

Quality

Made in
Germany



VOMM[®] GmbH

Pinzetten-Manufaktur
Prinzenstr.41
D-42697 Solingen

Bild-Preisliste Nr. 6.1

Telefon : 0212 329418
Fax : 0212 332631
e-mail : info@vomm.com
internet: <http://www.vomm.com>

Die geschäftlichen Beziehungen der Vertragspartner unterliegen auch für alle zukünftig zwischen den Vertragspartnern geschlossenen Verträge den nachstehenden

Verkaufs-, Lieferungs- und Zahlungsbedingungen.

Diese Bedingungen gehen - auch ohne ausdrücklichen zusätzlichen Widerspruch - entgegenstehenden Geschäftsbedingungen des Kunden vor. Anderslautende Vereinbarungen und Nebenabsprachen bedürfen der schriftlichen Bestätigung.

P r e i s e: Die Listenpreise verstehen sich zuzüglich der gesetzlichen Mehrwertsteuer. Sie beinhalten die Kosten für eine einfache Papierverpackung, jedoch keine Kosten für Außenverpackungen oder Verpackungen nach besonderer Vorschrift. Diese werden gesondert in Rechnung gestellt. Porto und Versandkosten, sowie Kosten für eventuelle Transportversicherung sind in den Preisen nicht enthalten.

L i e f e r u n g: Der Versand der Ware geschieht auf Kosten und Gefahr des Kunden. Falls keine besonderen Versendungsformen vereinbart werden, wählt die Firma VOMM nach bestem Ermessen, jedoch ohne Verpflichtung den kostengünstigsten Versandweg. Die durch besondere Wünsche entstehende Mehrfracht geht zu Lasten des Kunden. Für Kleinaufträge unter 50 € steht es der Firma VOMM frei eine zusätzliche Bearbeitungsgebühr von 5,50 € zu erheben. Liefermöglichkeiten bleiben der Firma VOMM vorbehalten, die auch keine Verpflichtung zur Einhaltung der genannten Lieferzeiten übernimmt. Die Firma VOMM ist jedoch bemüht, die genannten Lieferzeiten einzuhalten.

B e a n s t a n d u n g e n: Offensichtliche Mängel der gelieferten Ware berücksichtigt die Verkäuferin nur, wenn sie längstens innerhalb von einer Woche angezeigt werden. Die Mitteilung hierüber muß nachweislich innerhalb dieser Frist abgesandt oder mündlich bzw. telefonisch zugeleitet worden sein.

Bei begründeten Mängelrügen ist die Firma VOMM nach ihrer Wahl zur Nachbesserung oder zur Ersatzlieferung berechtigt. Wandlung des Kaufvertrages oder Minderung des Kaufpreises können nicht verlangt werden. Schadensersatzansprüche aller Art, insbesondere auch solche für mittelbare Schäden, sind ausgeschlossen.

Bei einem Fehlschlagen der Nachbesserungen bzw. Ersatzlieferung besteht für den Kunden das Recht, den Vertrag rückgängig zu machen bzw. den Kaufpreis angemessen herabzusetzen.

Bei Mängel an fremdbezogenen Produkten ist die Firma VOMM berechtigt, unter Abtretung ihrer eigenen Gewährleistungsansprüche den Kunden zunächst zur Durchsetzung seiner Gewährleistungsansprüche an den Lieferanten der Firma VOMM zu verweisen.

Für Waren die ohne Zustimmung der Firma VOMM zurückgesandt werden, ist jede Haftung ausgeschlossen.

H ö h e r e G e w a l t: Ein Ereignis höherer Gewalt berechtigt die Verkäuferin, die Lieferung um die Dauer der Behinderung und eine angemessene Anlaufzeit hinauszuschieben, oder ganz oder wegen des noch nicht erfüllten Teils vom Verträge zurückzutreten. Als höhere Gewalt in diesem Sinne gelten auch: Krieg, Grenzsperre, Streiks sowohl im eigenen als auch in einem für die Rohstofflieferung in Betracht kommenden Unternehmen, Beförderungsschwierigkeiten durch fehlende Transportmöglichkeiten, Feuer, Verkehrshindernisse und -störungen. Einschränkung oder Einstellung des Betriebes oder Zufuhr von Rohstoffen, kurz alle Umstände, welche die Herstellung der Ware beschränken oder unmöglich machen.

E i g e n t u m s v o r b e h a l t: Die Lieferung der Ware erfolgt unter Eigentumsvorbehalt gemäß § 455 BGB mit der Maßgabe, daß die Ware bis zur vollständigen Bezahlung sämtlicher, auch künftiger Forderungen aus der Geschäftsverbindung mit dem Kunden - also bis zum völligen Saldenausgleich oder bis zur vollen Einlösung in Zahlung gegebener Wechsel oder Scheck - Eigentum der Firma VOMM bleibt.

Der Kunde ist berechtigt, die Ware im ordnungsgemäßen Geschäftsgang zu veräußern. Er tritt aber schon jetzt alle ihm aus der Weiterveräußerung der Ware gegen seine Abnehmer zustehenden Forderungen an die Verkäuferin in Höhe der dann noch dieser gegenüber bestehenden Kaufpreisschuld ab. Auf Verlangen der Verkäuferin ist der Kunde verpflichtet, die Abtretung seinem Abnehmer bekanntzugeben und der Verkäuferin die zur Geltendmachung ihrer Rechte gegen den Abnehmer erforderlichen Auskünfte zu geben und Unterlagen auszuhändigen.

Für den Fall, daß das Eigentumsrecht der Firma VOMM durch Maßnahmen Dritter (Pfändung) oder durch besondere Ereignisse (Konkurs des Kunden etc.) beeinträchtigt werden könnte, ist der Kunde verpflichtet, der Firma VOMM umgehend Mitteilung zu machen und dritte Personen auf das Eigentumsrecht der Verkäuferin hinzuweisen.

Wird die Ware von dritter Seite gepfändet oder das Eigentum der Verkäuferin durch andere Maßnahmen gefährdet, so hat sie der Kunde hiervon unverzüglich unter Beifügung des Pfändungsprotokolls und der eidesstattlichen Erklärung des Inhalts, daß es sich bei dem von dem Dritten in Anspruch genommenen Gegenstand um das Eigentum der Verkäuferin handelt, zu benachrichtigen.

Bei Verarbeitung der Vorbehaltsware wird der Eigentumserwerb nach § 950 BGB ausgeschlossen. Der Eigentumsvorbehalt erstreckt sich dadurch anteilmäßig auf das durch die Verarbeitung neu entstandene Produkt.

Z a h l u n g s a r t: Rechnungen werden frühestens auf den Tag der Lieferung ausgestellt. Der Kaufpreis ist mit der Rechnungserteilung fällig. Die Rechnungsbeträge sind zahlbar innerhalb von acht Tagen nach Rechnungsdatum abzüglich 2% Skonto, bzw. innerhalb von 30 Tagen netto Kasse, wobei der Zahlungseingang bei der Firma VOMM bzw. die Gutschrift auf dem Konto der Firma VOMM maßgeblich ist. Die Aufrechnung oder die Geltendmachung eines Zurückbehaltungsrechtes des Kunden ist ausgeschlossen, es sei denn, es handelt sich um eine unbestrittene oder rechtskräftig festgestellte Forderung des Kunden.

Bei Zielüberschreitung werden angemessene, jedenfalls aber 2% über dem jeweils geltenden Diskontsatz der Deutschen Bundesbank liegende Verzugszinsen berechnet.

Auf Porto- und Verpackungskosten wird kein Skonto gewährt.

S o n s t i g e s: Geringfügige Änderungen, welche dem Fortschritt dienen, behält sich die Firma VOMM vor. Abweichungen in der Ausführung von Werkzeugen, welche die Funktion nicht beeinträchtigen, beruhen auf Handarbeit und gelten als unvermeidbar.

E r f ü l l u n g s o r t u n d G e r i c h t s s t a n d: Erfüllungsort für Lieferungen und Leistungen für alle sich aus dem Geschäft ergebenden beiderseitigen Rechte und Pflichten ist Leichlingen. Gerichtsstand ist Solingen. Dies gilt insbesondere auch für das gerichtliche Mahnverfahren.

T e i l n i c h t i g k e i t: Sollte ein Punkt dieser Verkaufs-, Lieferungs- und Zahlungsbedingungen nichtig sein, so behalten alle übrigen Punkte ihre volle Rechtskraft. Ein nichtiger Punkt ist durch den rechtlich wirksamen zu ersetzen, der dem gewollten wirtschaftlich am nächsten kommt.

A n z u w e n d e n d e s R e c h t: Soweit nichts anderes vereinbart ist, gelten unabdingbar die gesetzlichen Bestimmungen der Bundesrepublik Deutschland.

Material-Code, z. B. bei Modell 5a:

5a	Stahl vernickelt bzw. blank eingeölt <i>Carbon Steel, nickel-plated or oiled</i>
5a S	Rostfreier Chromstahl, gehärtet <i>Stainless Chrome-Steel, hardened</i>
5a SA	Chrom/Nickel-Edelstahl, Rostfrei, antimagnetisch und bedingt säurebeständig <i>Chrome/Nickel-Steel, Stainless, anti-magnetic and anti-acid</i>
5a SA-T	dto., jedoch ganz Teflon beschichtet <i>same, but tips coated with Teflon (PTFE)</i>
5a SA-PVD	dto., jedoch komplett mit PVD-Beschichtung <i>same, but completely PVD-coated</i>
5a SA-ESD	<i>Schutz vor elektronischer Überbelastung bei Bauteilen, elektrostatisch hoch-ohmig ableitend, mit TÜV-Zertifikat ESD.</i> <i>Protection against electronic overload as far as chip components are concerned, electrostatic OHM-conductive, with TÜV-Certificate ESD.</i>
R5a SA	dto, jedoch als selbstklemmende, durchgesteckte Kreuzpinzette <i>same, but manufactured as reversible Tweezer (box-joint)</i>
5a TA	Titan <i>Titanium</i>
5a NS	Neusilber <i>German Silver</i>
5a CA	Spezialstahl, Rostfrei, un-magnetisch und super-säurebeständig <i>Special alloy, stainless, non-magnetic and super-acid-resistant</i>
5a ALU	Aluminium <i>Aluminium</i>
5a M	Messing <i>Brass</i>

Nachdruck, vollständig oder auch ausdrucksweise, sowie Weitergabe oder Vervielfältigung ist ohne die ausdrückliche schriftliche Genehmigung untersagt!

Diese Bild-Preisliste annulliert alle vorherigen Preislisten.

Alle Preise zuzüglich der gesetzlichen Mehrwertsteuer

Das Eigentumsrecht an der Bild-Preisliste bleibt vorbehalten.

Alle Zeichnungen sind so naturgetreu wie möglich, aber unverbindlich.

Modelländerungen vorbehalten.



INHALTSVERZEICHNIS / TABLE OF CONTENTS

Seiten	
5	Diverse gängige Pinzetten
6	Diverse gut laufende Pinzetten
7	Diverse sehr gefragte Pinzetten
8	Universalpinzetten, ESD-beschichtete Pinzetten
9	Universalpinzetten, ESD-beschichtete Pinzetten PTFE-(Teflon) beschichtete Pinzetten
10	Universalpinzetten, ESD-beschichtete Pinzetten
11	Universalpinzetten, ESD-beschichtete Pinzetten
12	Biegepinzetten, ESD-beschichtete Pinzetten
13	Spezialpinzetten für SMD-Bauteile, ESD-beschichtete Spezialpinzetten
14	Waferpinzetten, PTFE-(Teflon) beschichtete Waferpinzetten
15	Waferpinzetten, PTFE-(Teflon) beschichtete Waferpinzetten
16	Waferpinzetten, PTFE-(Teflon) beschichtete Waferpinzetten
17	Spitze Pinzetten
18	Stumpfe Pinzetten
19	Spitze Montagepinzetten
20, 46	Spitze, schutzisolierte, PVC-beschichtete Pinzetten
20	Auswechselbare, auf spitze + breite Pinzetten
21, 22, 23	Steckerzieher-Pinzetten 120 mm lang
24	Schwere Steckerzieher-Pinzetten, 145 mm lang
25, 26, 27	Diverse Kreuzpinzetten
27	Keramikpinzetten und Trimmer
28	Manikürpinzetten
28	Skalpellgriffe und diverse Klängen
29	Lackabkratzer, Chipklemmpinzetten, Feststellpinzetten
30	Juwelierpinzetten, Aufnahme Kreuzpinzetten
31	Schneide-, Wäge-, Pinzetten zur Aufnahme von Minimelves
32, 55	Mundspiegel, Kehlkopfspiegel, Teleskopgriffe
33, 34, 37	Haken, Sonden, Excavatoren
35, 34	Mikrospatel Mikrolöffel, Löthaken, Pulverspatel
38, 39, 40, 41	Nichtmetallische (Kunststoffpinzetten, Klemmen)
42, 43, 44, 45	Nichtmetallische (Kunststoffpinzetten), Nadelhalter, Klemmen, Zangen
46	Schutzisolierte Pinzetten
47	Schneidepinzetten, Feilchenfeldpinzetten
48	Klemmgreifer, Krallengreifer
49, 50	Vakuumpinzetten
51	Saugnadeln, Sauger
52	Vakuum-Saugschlauch
53	Fingersauggriffel, Handsauggriffel, Spezialsaugvorrichtung
54	Tool-Servant / Pinzettenhalter
55	Griffe, Teleskopgriffe, Spiegel

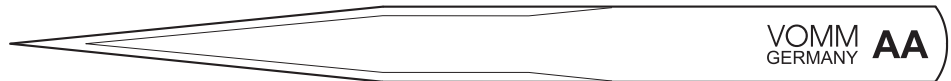

AA	9184	6,60 €
AA S	9284	7,66 €
AA SA	9384	8,10 €
AA M	9484	10,50 €

Universalpinzette, sehr populär
Universal Tweezer, very popular

130 mm



No Nickel-Allergy!

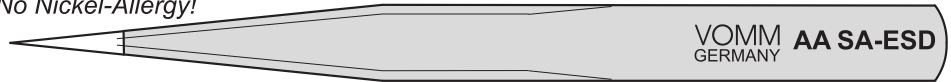

AA SA-ESD	3616	8,06 €
------------------	------	---------------

Wie AA SA, jedoch ESD-beschichtet
Same as AA SA, but ESD-coated



130 mm

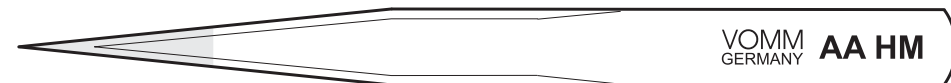

AA HM	8400	44,16 €
--------------	------	----------------

Wie AA S, jedoch mit Hartmetall bestückt
Same as AA S, but tips fitted with Hardmetal

128 mm

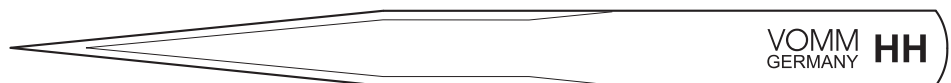

HH	8184	7,36 €
-----------	------	---------------

Universalpinzette, sehr populär *Universal Tweezer, very popular*

120 mm

Ac	9000	10,36 €	stabil heavy		VOMM GERMANY Ac	110 mm
-----------	------	----------------	-----------------	--	------------------------	--------

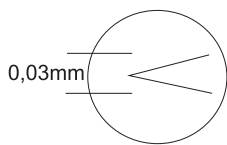

BB	9390	7,14 €
-----------	------	---------------

Leichte Hohlpinzette, Spitze mit Ansatz
Light-weight and hollow, structured point

115 mm



F SA	9382	11,24 €
-------------	------	----------------

Flache Spitzen wie 2a, jedoch eckig
Flat tips as 2a, but square

120 mm

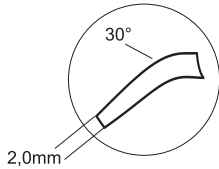

Fb SA 9640 13,34 €

Flach-eckige Spitzen wie F, jedoch gebogen
Flat square tips as F, but bent

117 mm



GG SA 9388 11,86 €

Amerikanische Form
American Style

130 mm



No Nickel-Allergy!



GG SA-ESD 3617 10,58 €

Wie GG SA, jedoch ESD-beschichtet
Same as GG SA, but ESD-coated

130 mm



PSF SA 9389 10,14 €

Wie AA, jedoch eckig-breite Spitze mit Zahnung
Same as AA, but fine square tips with serration

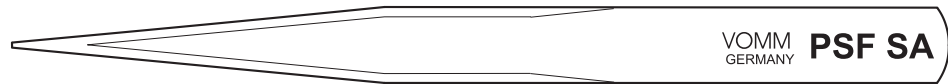

PSF SA 9385 8,84 €

Wie AA, jedoch eckig-breite Spitze ohne Zahnung
Same as AA, but fine square tips without serration

130 mm



RR 9015 10,94 €

Breit und stark
Broad and strong

145 mm



No Nickel-Allergy!

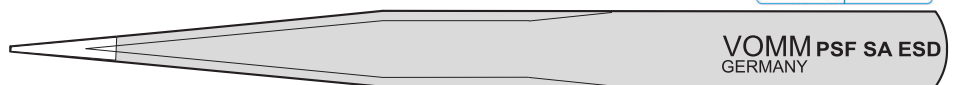

PSF SA-ESD 3615 9,92 €
 3633 10,48 €

Wie PSF SA, jedoch ESD-beschichtet
Same as PSF SA, but ESD-coated
 Wie PSF SA- ESD, jedoch mit Zahnung
Same as PSF SA - ESD, but serrated

130 mm



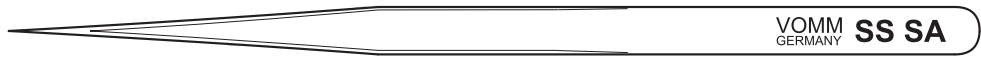

SS SA 9387 **11,08 €** Schlank und schwach
Narrow, low resilience 135 mm

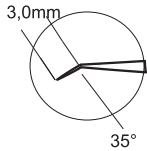

SSbb SA 6971 **12,90 €** Wie SS, jedoch Spitze kurz gebogen
Same as SS, but tips short bent 133 mm

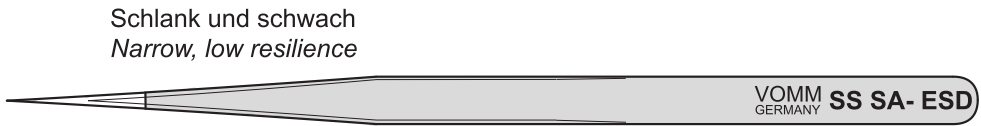

Schlank und schwach
Narrow, low resilience

No Nickel-Allergy!



SS SA-ESD 3619 **11,76 €** Wie SS SA, jedoch ESD-beschichtet *Same as SS SA, but ESD-coated*

SSbb SA-ESD 3613 **13,02 €** Wie SSbb SA, jedoch ESD-beschichtet *Same as SSbb SA, but ESD-coated*

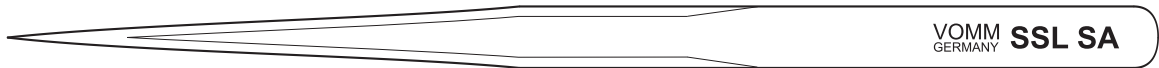

SSL SA 9487 **14,10 €** Länger und stärker als SS
Longer and stronger than SS 160 mm

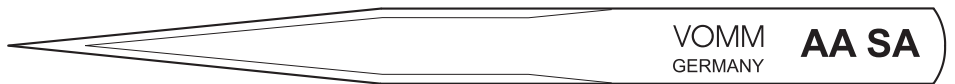

AA SA 9386 **8,74 €** Wie AA, jedoch mit Zahnung
Same as AA, but with serration 130 mm



VOMM GERMANY 00 SA

00 SA 8700 12,60 €

Dick, mittelfeine Spitzen *Thick, semi-pointed tips*

120 mm



No Nickel-Allergy!



VOMM GERMANY 00 SA-ESD

00 SA-ESD 3629 13,84 €

Wie 00 SA, jedoch ESD-beschichtet *Same as 00 SA, but ESD-coated*



VOMM GERMANY 0c9 SA

0c9 SA 8710 10,36 €

schmal, glatt *narrow, smooth*

90 mm

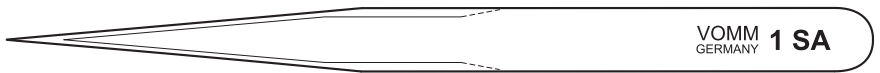

VOMM GERMANY 1 SA

1 SA 8980 10,50 €

Universell einsetzbar *All Purpose Tweezer*

120 mm



No Nickel-Allergy!

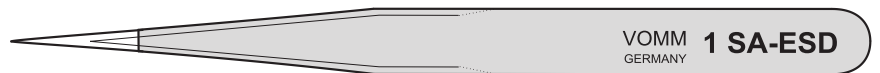

VOMM GERMANY 1 SA-ESD

1 SA-ESD 3628 10,60 €

Wie 1 SA, jedoch ESD-beschichtet *Same as 1 SA, but ESD-coated*



120 mm

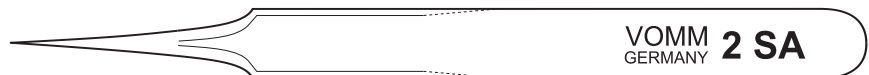

VOMM GERMANY 2 SA

2 SA 9381 11,10 €

Mittelfeine Spitzen *Semi-pointed tips*

120 mm



No Nickel-Allergy!

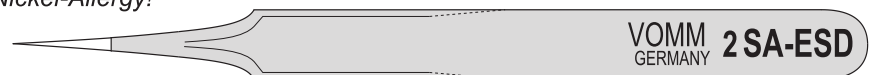

VOMM GERMANY 2 SA-ESD

120 mm

Mittelfeine Spitzen *Medium-fine tips*



2 SA-ESD 3609 9,58 €

Wie 2 SA, jedoch ESD-beschichtet *Same as 2 SA, but ESD-coated*



VOMM GERMANY 2aSA

2a SA 9378 11,10 €

Flach-runde Spitzen *Flat-round tips*

120 mm

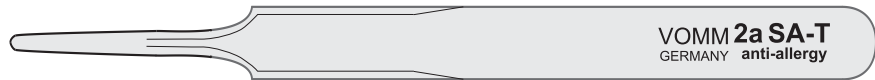

VOMM GERMANY **2a SA-T**
anti-allergy

2a SA-T 9478 **17,06 €**

Wie 2a SA, jedoch mit PTFE beschichtet
Same as 2a SA, but coated with PTFE

120 mm



No Nickel-Allergy!



VOMM GERMANY **2a SA-ESD**

120 mm

2a SA-ESD 3611 **10,08 €**

Wie 2a SA, jedoch ESD-beschichtet
Same as 2a SA, but ESD-coated

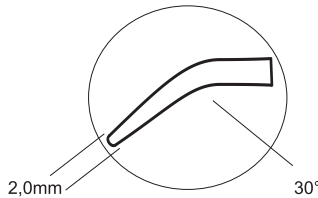

VOMM GERMANY **2ab SA**

2ab SA 9368 **13,82 €**

Spitze wie 2a, jedoch winklig gebogen
Same tips as 2a, bent

117 mm



VOMM GERMANY **3 SA**

3 SA 9383 **11,24 €**

Spitz

3M 9483 **14,70 €**

Pointed

120 mm



No Nickel-Allergy!



VOMM GERMANY **3 SA-ESD**

120 mm

3 SA-ESD 3608 **10,24 €**

Wie 3 SA, jedoch ESD-beschichtet
Same as 3 SA, but ESD-coated

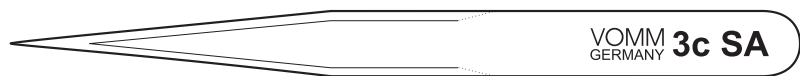

VOMM GERMANY **3c SA**

3c S 9683 **11,38 €**

Rostfrei
Stainless

110 mm

3c SA 9783 **11,24 €**

Wie 3, jedoch kürzer
Same as 3, but shorter

110 mm



No Nickel-Allergy!

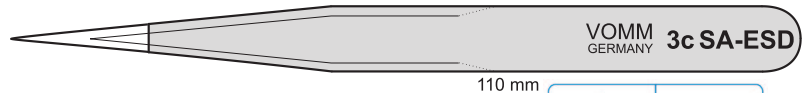

3c SA-ESD 3610 10,24 €

Wie 3c SA, jedoch ESD-beschichtet

Same as 3c SA, but ESD-coated



4 S 9679 11,80 €

Rostfreier Chromstahl gehärtet Stainless Chrome-Steel hardened

110 mm

4 SA 9779 11,24 €

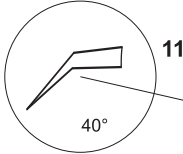

Spitz, Pointed



VOMM GERMANY **4 SA**

110 mm



VOMM GERMANY **4b SA**

Spitz, gebogen Pointed, bent

4b S 9280 13,38 €

Rostfreier Chromstahl gehärtet Stainless Chrome-Steel hardened 110 mm

4b SA 9380 11,86 €

Chrom / Nickel - Edelstahl Chrome / Nickel - Steel hardened 110 mm



No Nickel-Allergy!

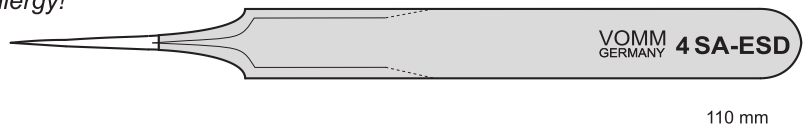

4 SA-ESD 3618 10,58 €

Wie 4 SA, jedoch ESD-beschichtet

Same as 4 SA, but ESD-coated



MF 5 SA 9379.1 15,18 €

Chrom / Nickel - Edelstahl 110 mm

Very pointed Sehr spitz



anti-acid
STAINLESS-ANTIMAGNETIC

VOMM GERMANY **5 SA**

5 S 9279 11,18 €

Rostfreier Chromstahl gehärtet Stainless Chrome-Steel hardened 110 mm

5 SA 9379 11,24 €

Chrom / Nickel - Edelstahl Chrome / Nickel - Steel hardened 110 mm



No Nickel-Allergy!



5 SA-ESD 3604 10,58 €

Wie 5 SA, jedoch ESD-beschichtet

Same as 5 SA, but ESD-coated

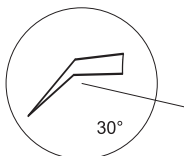

anti-acid
STAINLESS-ANTIMAGNETIC

VOMM GERMANY **5bb SA**

107 mm

5bb SA 6972 12,60 €

Sehr spitz, kurz gebogene Spitze, 3mm lang

Very pointed, short bent tips, 3mm long

5bb SA-ESD 3627 12,70 €

Wie 5bb SA, jedoch ESD-beschichtet

Same as 5bb SA, but ESD-coated

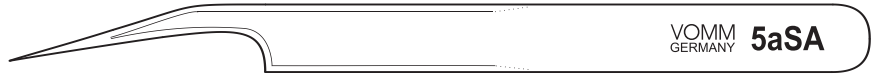

5a SA

9377

11,70 €

Spitz
Pointed

120 mm

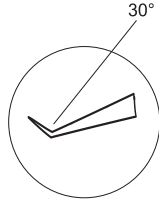

5abb SA

6970

13,34 €

Feine, kurz gebogene Spitze

Fine, short bent tips

117 mm

5abb SA-ESD

3625

14,10 €

Wie 5abb SA, jedoch ESD-beschichtet

Same as 5abb SA, but ESD-coated

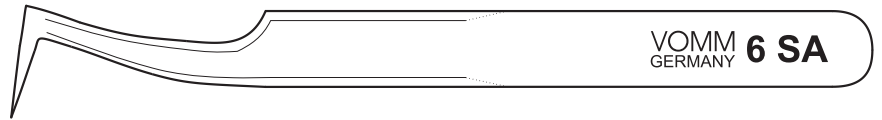

6 SA

6987

13,20 €

Feine Hakenspitze
Fine, hooked tips

120 mm



1,0mm

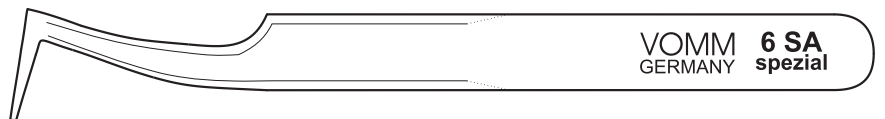

6 spez. SA

6986

13,32 €

Wie 6 SA, jedoch eckige Spitze
Same as 6 SA, but square tips

115 mm

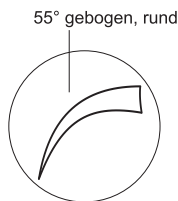

55° gebogen, rund

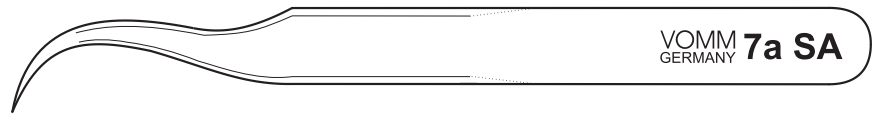

7a SA

9376

13,50 €

Feine Sichelspitze *Fine lunate tips*

120 mm

7a SA-T

9391

19,52 €

Wie 7a SA, jedoch Teflon-beschichtet *Same as 7a SA, but Teflon-coated*

120 mm



No Nickel-Allergy!

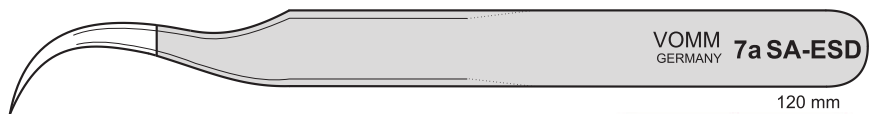

7a SA-ESD

3605

13,26 €

Wie 7a SA, jedoch ESD-beschichtet
Same as 7a SA, but ESD-coated

120 mm



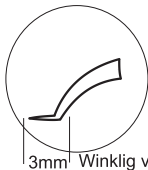

3mm Winklig versetzt 30°



Feine Sichelform mit kurzer gerader Spitze, 3mm lang

7abb SA 6950 15,72 €

Fine lunate shape with short straight tips, 3mm long

120 mm

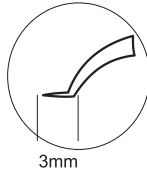

3mm Winklig versetzt 30°

No Nickel-Allergy!



Wie 7abb SA, jedoch ESD-beschichtet

Same as 7abb SA, but ESD-coated



7abb SA-ESD 3612 15,86 €

120 mm



120 mm

7 SA 9375 12,14 €

mit kurzer gerader Spitze

shape with short straight tips

7 SA-ESD 3630 13,02 €

Wie 7 SA, jedoch ESD-beschichtet

Same as 7 SA, but ESD-coated

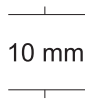
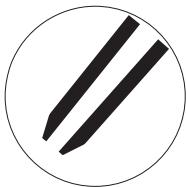

10 mm



Biegepinzette

Forming Tweezer

8 SA 3800 11,70 €

120 mm

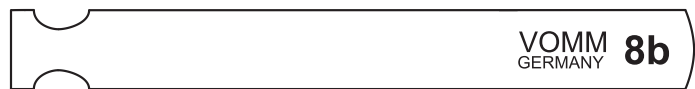

Biegepinzette

Forming Tweezer

8b 3802 10,18 €

100 mm

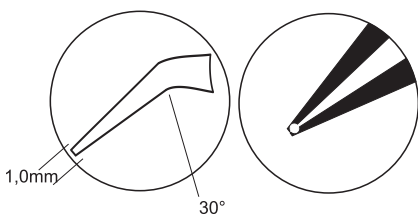

1,0mm

30°



Passend für Mini-MELF, Einfräsung $\varnothing 0,5\text{mm}$

For Mini-MELF, milled slot, $\varnothing 0,5\text{mm}$

11 SA-SMD 6611 13,82 €

117 mm

8 SA-SMD 6615 **13,50 €**



Glatt

Smooth

VOMM GERMANY **8 SA SMD**

120 mm

8a SA-SMD 6617 **15,30 €**

Mit Einfräsung, $\varnothing 0,5$ mm *Milled slot, $\varnothing 0,5$ mm*

VOMM GERMANY **8a SA SMD**

120 mm

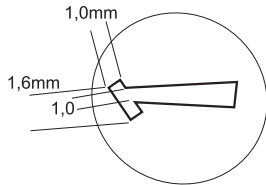

8b SA-SMD 6616 **13,96 €**

Wie 8 SA-SMD, jedoch gebogen *Same as 8 SA-SMD, but bent*

8b SA SMD-ESD 3624 **13,48 €**

Wie 8b SA-SMD, jedoch ESD-beschichtet *Same as 8b SA-SMD, but ESD-coated*

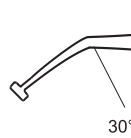

VOMM GERMANY **8b SA SMD**

120 mm

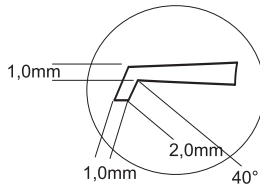

12 SA-SMD 6612 **13,20 €**

Spezialpinzette, u.a. für SMD-Bauelemente *Special Tweezer, e.g. for SMT-Chips*

VOMM GERMANY **12 SA SMD**

120 mm

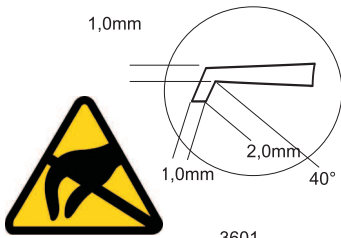

12 SA-SMD ESD 3601 **12,92 €**

No Nickel-Allergy!

Wie 12 SMD, jedoch ESD-beschichtet

Same as 12 SMD, but ESD-coated



VOMM GERMANY **12 SA SMD-ESD**

120 mm

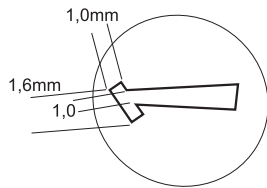

13 SA-SMD 6613 **13,20 €**

Spezialpinzette, u.a. für SMD-Bauelemente

Special Tweezer, e.g. for SMT-Chips

VOMM GERMANY **13 SA SMD**

120 mm

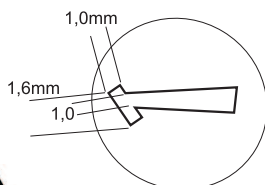

13 SA-SMD ESD 3602 **12,92 €**

No Nickel-Allergy!

Wie 13 SMD, jedoch ESD-beschichtet

Same as 13 SMD, but ESD-coated



VOMM GERMANY **13 SA SMD-ESD**

120 mm



14 S 7977 **13,20 €** Spitzen 4 mm breit
Tips 4 mm wide 115 mm



15a 9501 **37,12 €** Schneidepinzette
Cutting-Tweezer 115 mm



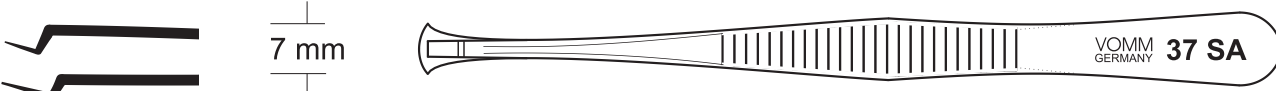

72a SA 7299 **14,84 €** Waferpinzette, 3 mm breite Spitze
Wafer Tweezer, 3 mm wide tips 115 mm

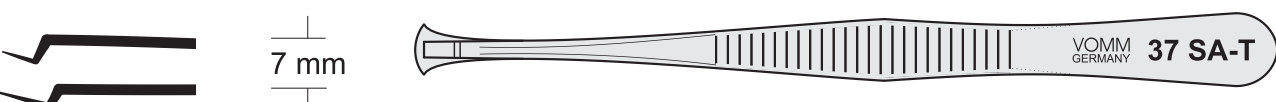

37 SA 3729 **20,36 €** Waferpinzette mit 2 Anschlagwinkel und schmalem Oberteil
Wafer Tweezer with 2 stop pins and narrow upper-shank 120 mm



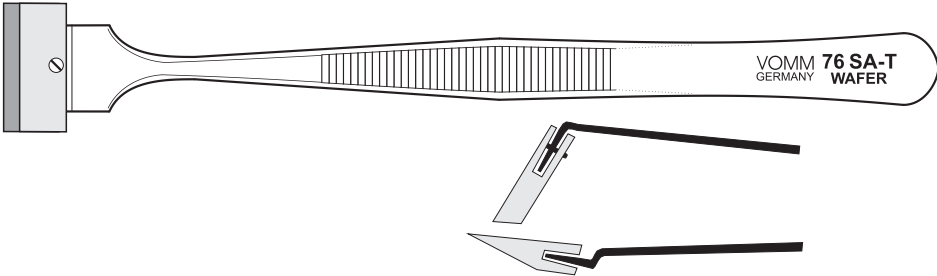

NEU! NEW!
37 SA-T 3731 **26,34 €** Waferpinzette mit 2 Anschlagwinkel und schmalem Oberteil, PTFE-beschichtet
Wafer Tweezer with 2 stop pins and narrow upper-shank, coted with PTFE 120 mm

76 SA-T 6070 **43,26 €** Waferpinzette, 31 mm breit, mit Teflon-Paddel
Wafer Tweezer, 31 mm wide, with PTFE Pad 125 mm

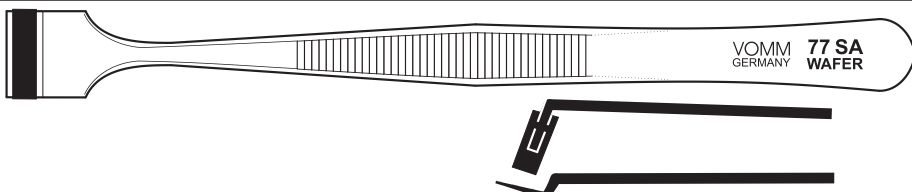
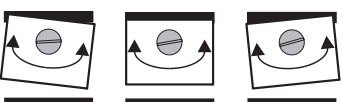
77 SA-T 3779 **24,54 €** Waferpinzette, 12 mm breit, mit Teflon-Paddel
Wafer Tweezer, 12 mm wide, with PTFE Pad 125 mm

NEU! NEW!
79 SA-T 3780 **30,44 €** Waferpinzette, 20 mm breit, mit Teflon-Paddel
Wafer Tweezer, 20 mm wide, with PTFE Pad 125 mm

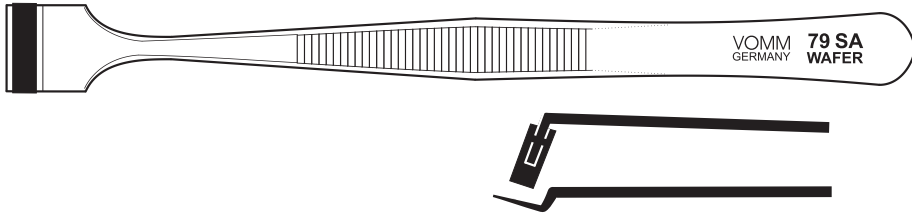

91 SA 7600 **14,56 €**

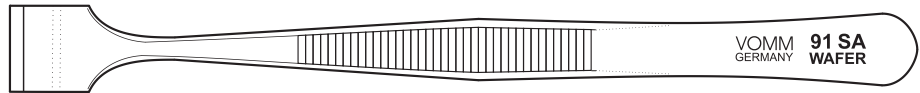
Waferpinzette, 12 mm breit
Wafer Tweezer, 12 mm wide

125 mm

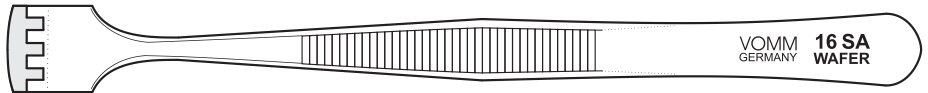

16 SA 4149 **14,98 €**

Wafer Pinzette, 12 mm breit
Wafer Tweezer, 12 mm wide

16 SA-T 4150 **20,80 €**

Wie 16 SA, jedoch ganz Teflon beschichtet
Same as 16 SA, but coated with Teflon

125 mm

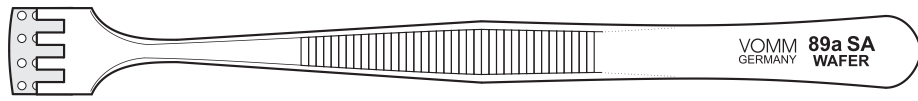

89 SA 3948 **15,44 €**

Wafer Pinzette, 9 mm breit *Wafer Tweezer, 9 mm wide*

125 mm

89a SA 3949 **16,44 €**

Wafer Pinzette, 12 mm breit *Wafer Tweezer, 12 mm wide*

125 mm

89 SA-T 3951 **22,00 €**

Wie 89 SA, jedoch ganz Teflon beschichtet

125 mm

89a SA-T 3950 **21,42 €**

Same as 89a SA, but coated with Teflon

125 mm

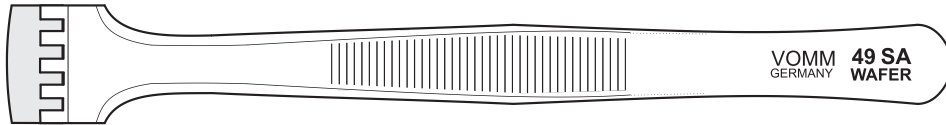

49 SA 4159 **15,72 €**

Waferpinzette, 16 mm breit
Wafer Tweezer, 16 mm wide

125 mm

49 SA-T 4160 **21,50 €**

Wie 49 SA, jedoch ganz Teflon beschichtet
Same as 49 SA, but coated with Teflon

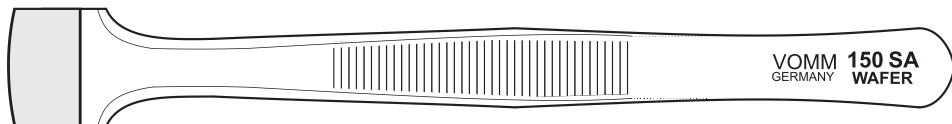

150 SA 5039 **24,68 €**

Waferpinzette, 16 mm breit
Wafer Tweezer, 16 mm wide

125 mm

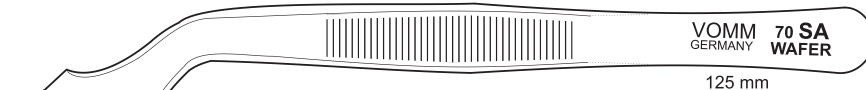

70 SA 6069 **28,24 €**

Waferpinzette, 20 mm breit / *Wafer Tweezer, 20 mm wide*

125 mm

60 SA 6073 **22,88 €**

Wie 70 SA, jedoch gerade / *Same as 70 SA, but straight*

60 SA-T 6074 **30,96 €**

Wie 60 SA, jedoch ganz Teflon beschichtet *Same as 60 SA, but coated with Teflon*

38a SA

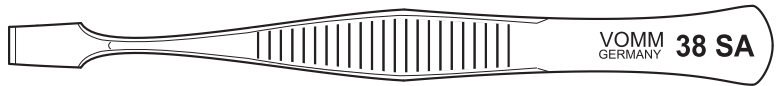

38 SA 9585 **10,64 €**

Flach-breite Spitze, gerade *Flat, broad Tips*

105 mm

38a SA 9587 **11,54 €**

Wie 38 SA, jedoch gebogene Spitze *Same as 38 SA, but bent tips*

103 mm

38a 9589 **1,06 €**

Vernickelt, Preisgünstig *Nickel-plated, Low-Cost*

103 mm

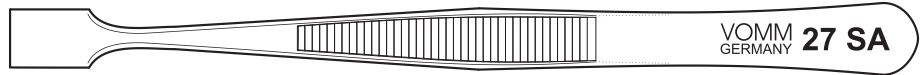
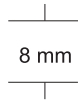

27 SA
27a SA

9600 **11,10 €**
9620 **14,70 €**

Flach und eckig *Flat and square*
dto, jedoch gebogen *Same, but bent*



125 mm
123 mm

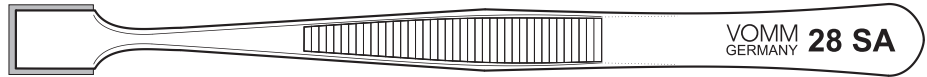
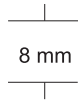

28 SA
28a SA

9610 **11,70 €**
9630 **15,90 €**

Wie 27 SA, mit Filz *Same as 27, with felt*
dto, jedoch gebogen *Same, but bent*



125 mm
123 mm

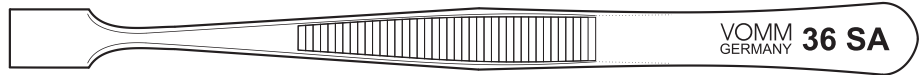
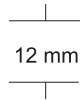

36 SA
36a SA

7715 **11,24 €**
7716 **12,14 €**

Flach und eckig *Flat and square*
dto, jedoch gebogen *Same, but bent*



125 mm
123 mm

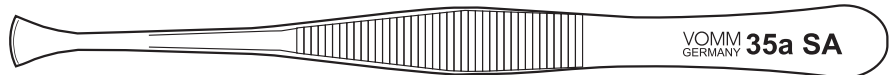

35a SA

7982 **11,40 €**

Halbrunde, dünne Spitzen
Half-round and thin tips

120 mm

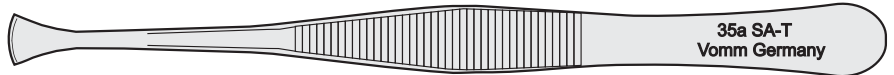

35a SA-T

7983 **17,40 €**

Wie 35a SA, jedoch ganz mit PTFE beschichtet
Same as 35a SA, but completely coated with PTFE

120 mm

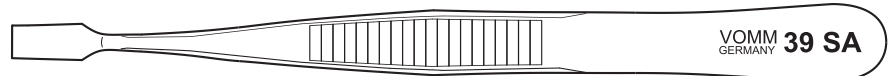
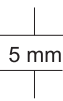

39 SA
39a SA

9584 **11,10 €**
9588 **12,14 €**

Flach und eckig *Flat and square*
dto., jedoch gebogen *Same, but bent tips*

125 mm
123 mm

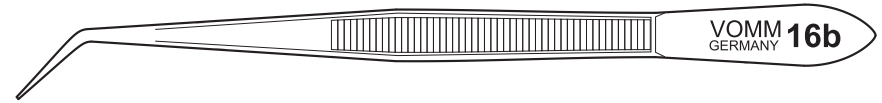
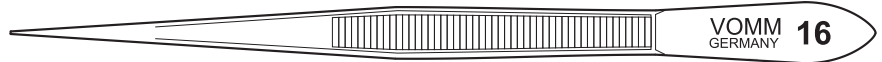
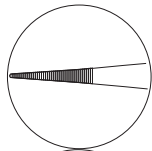

16	2010	5,86 €	Vernickelt, Spitze mit feiner Zahnung		120 mm
16b	2011	6,74 €	Nickel-plated, fine-serrated tips		120 mm

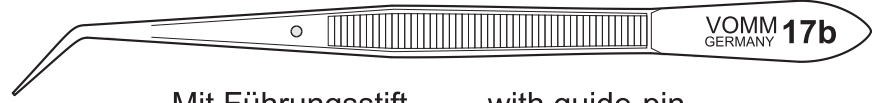
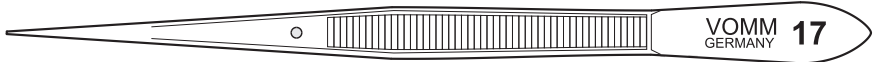
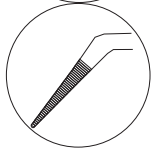
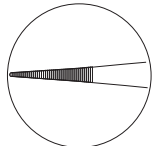

Mit Führungsstift with guide-pin

17	2012	7,36 €	wie Mod. 16	as Mod. 16	120 mm
17b	2013	8,70 €	wie Mod. 16b	as Mod. 16b	120 mm

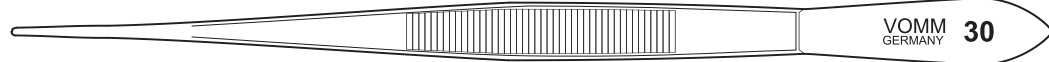
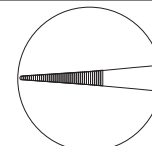

30	5010	7,36 €	vernickelt, feine Zahnung	nickel-plated, fine serrated	145 mm
32	5110	9,30 €	vernickelt, feine Zahnung	nickel-plated, fine serrated	165 mm
34 SA	5210	9,60 €	18/10, feine Zahnung	stainless,antimagnetic, fine serrated	120 mm

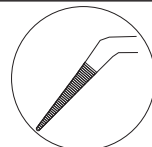

30b	5011	7,96 €	vernickelt, feine Zahnung	nickel-plated, fine serrated	145 mm
32b	5111	10,50 €	vernickelt, feine Zahnung	nickel-plated, fine serrated	165 mm
34b SA	5211	10,18 €	18/10, feine Zahnung	stainless,antimagnetic, fine serrated	120 mm

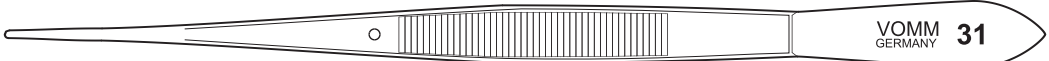
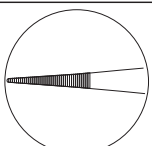

Mit Führungsstift with guide-pin

31	5012	8,56 €	vernickelt, feine Zahnung	nickel-plated, fine serrated	145 mm
33	5112	11,10 €	vernickelt, feine Zahnung	nickel-plated, fine serrated	165 mm
35 SA	5212	10,78 €	18/10, feine Zahnung	stainless,antimagnetic, fine serrated	120 mm

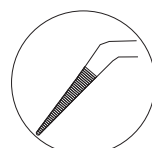

Mit Führungsstift with guide-pin

31b	5013	9,16 €	vernickelt, feine Zahnung	nickel-plated, fine serrated	145 mm
33b	5113	11,70 €	vernickelt, feine Zahnung	nickel-plated, fine serrated	165 mm
35b SA	5213	11,24 €	18/10, feine Zahnung	stainless,antimagnetic, fine serrated	120 mm

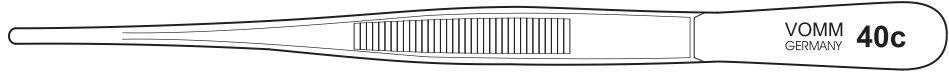
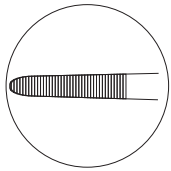

40c 3009 7,36 € Universalpinzette, 2 mm schmale, fein gezahnte Spitzen *Universal Tweezer, narrow 2 mm wide, fine serrated points* 130 mm

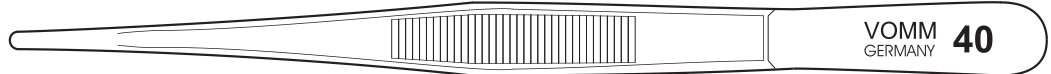
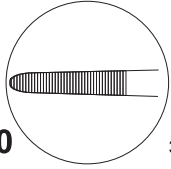

40	3010	7,36 €	Vernickelt	Nickel-plated	145 mm
47	3311	9,78 €	Vernickelt	Nickel-plated	180 mm
42	3110	12,14 €	Vernickelt	Nickel-plated	200 mm
48	3312	18,18 €	Vernickelt	Nickel-plated	250 mm
46	3310	22,32 €	Vernickelt	Nickel-plated	300 mm
44 SA	3210	9,30 €	Rostfrei, antimagnetisch	Stainless, antimagnetic	120 mm
44 S	3214	9,20 €	Rostfrei, gehärtet	Stainless, hardened	120 mm
40 SA	3014	10,04 €	Rostfrei, antimagnetisch	Stainless, antimagnetic	145 mm
40 SA-ESD	3606	10,52 €	Wie 40 SA, jedoch ESD-beschichtet	Same as 40 SA, but ESD-coated	145 mm
69 SA	3019	18,02 €	Rostfrei, antimagnetisch	Stainless, antimagnetic	200 mm
71 S	4412	20,78 €	Rostfrei, gehärtet	Stainless, hardened	250 mm

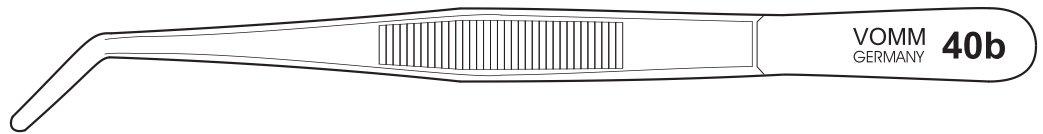
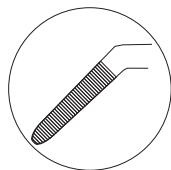

40b	3011	7,96 €	vernickelt	nickel-plated	145 mm
42b	3111	12,90 €	vernickelt	nickel-plated	200 mm
44b SA	3211	10,04 €	Rostfrei, antimagnetisch	Stainless, antimagnetic	120 mm

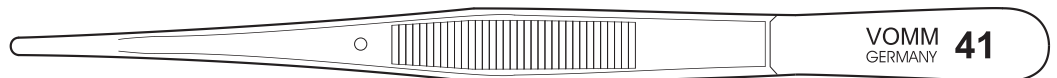
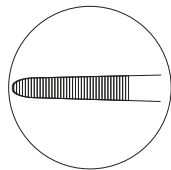

Mit Führungsstift with guide-pin

41	3012	9,16 €	vernickelt	nickel-plated	145 mm
43	3112	13,64 €	vernickelt	nickel-plated	200 mm
45 SA	3212	10,50 €	Rostfrei, antimagnetisch	Stainless, antimagnetic	120 mm

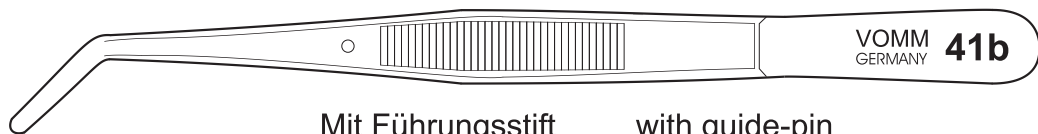
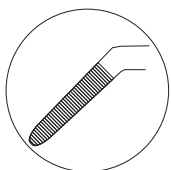

Mit Führungsstift with guide-pin

41b	3013	9,74 €	vernickelt	nickel-plated	145 mm
43b	3113	14,38 €	vernickelt	nickel-plated	200 mm
45b SA	3213	11,24 €	Rostfrei, antimagnetisch	Stainless, antimagnetic	120 mm

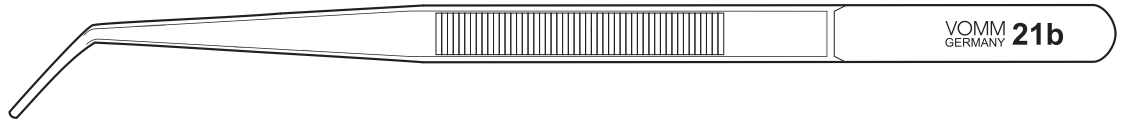
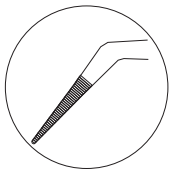

21b

9152

6,92 €

Preisgünstige Universalpinzette, geriefelte Spitzen

Low-Cost Tweezer, serrated points

155 mm

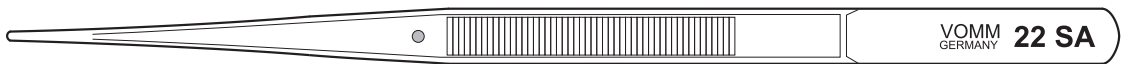
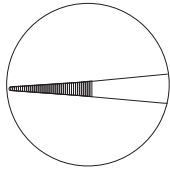

Mit Führungsstift

with guide-pin

22

9155

7,96 €

vernickelt

nickel-plated

155 mm

22 S

9156

9,16 €

dto., aber Rostfrei

same, but stainless

155 mm

22 SA

9159

10,36 €

dto., aber Antimagnetisch

same, but antimagnetic, stainless

155 mm

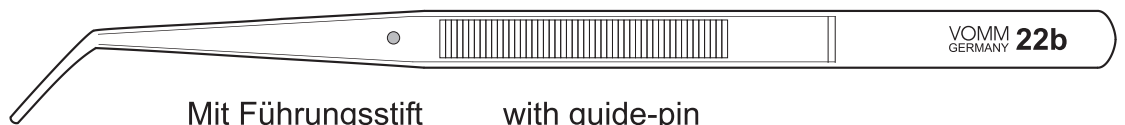
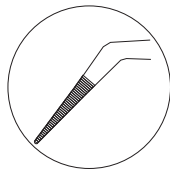

Mit Führungsstift

with guide-pin

22b

9153

8,24 €

wie Mod. 22, gebogen

same as Mod. 22, bent tips

155 mm

22b S

9154

9,74 €

wie Mod. 22 S, gebogen

same as Mod. 22 S, bent tips

155 mm

22b SA

9160

10,64 €

wie Mod. 22 SA, gebogen

same as Mod. 22 SA, bent tips

155 mm

No Nickel-Allergy!

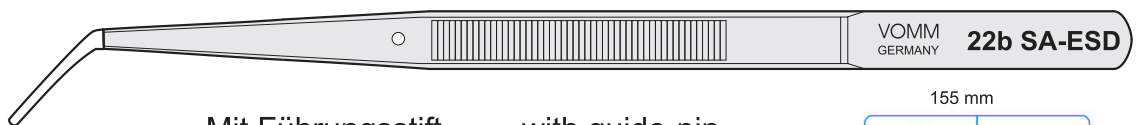

Mit Führungsstift

with guide-pin

22b SA-ESD

3632

10,70 €

wie Modell 22b SA, jedoch ESD-beschichtet

22 SA-ESD

3607

9,24 €

same as Model 22 SA, but ESD-coated

155 mm

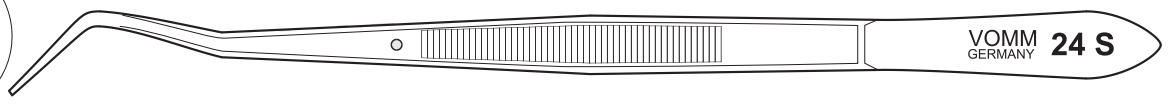
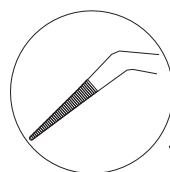

Mit Führungsstift

with guide-pin

24 S

9161

13,50 €

Typ Meriam, geriefelte Spitzen

Meriam Type, serrated points

155 mm

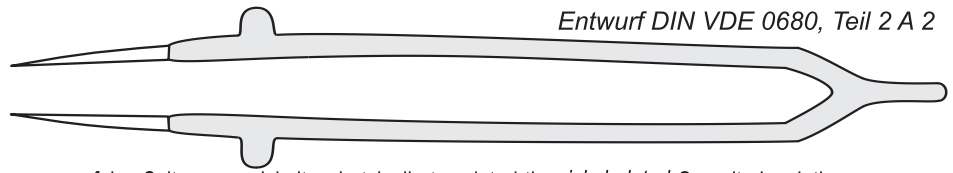

Entwurf DIN VDE 0680, Teil 2 A 2

AA SEC

8804

12,44 €

feine Spitzen, vernickelt, schutzisoliert *pointed tipsnickel-plated, Security-Insulation*

125 mm

AA SA-SEC

8805

14,70 €

(AA SA-SEC = Rostfrei, antimagnetisch) (AA SA-SEC = *Stainless, antimagnetic*)

125 mm

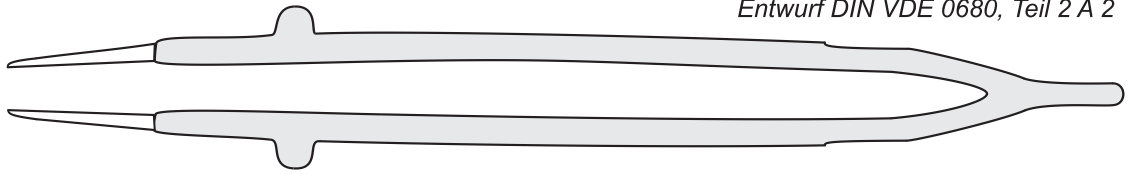
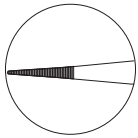

Entwurf DIN VDE 0680, Teil 2 A 2

22 SEC

8802

12,44 €

gerade, mittelfeine Spitzen, schutzisoliert (22b SEC=gebogen)

155 mm

22b SEC

8803

13,08 €

straight, medium pointed, Security-Insulation (22b SEC=bent)

155 mm

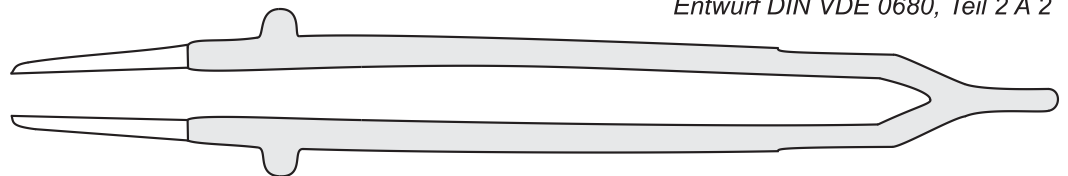
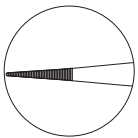

Entwurf DIN VDE 0680, Teil 2 A 2

40 SEC

8801

12,44 €

gerade, breite Spitzen, schutzisoliert

straight, blunt pointed, Security-Insulation

145 mm

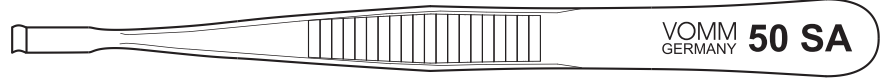
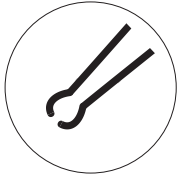

50 SA

2141

10,78 €

3 mm schmale Spitze, Aufnahme \varnothing 0,8 mm

3 mm wide tips, \varnothing 0.8 mm

120 mm

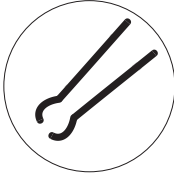

No Nickel-Allergy!

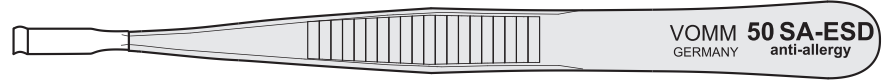

50 SA-ESD

3620

10,68 €

Wie 50 SA, jedoch ESD-beschichtet

Same as 50 SA, but ESD-coated

120 mm

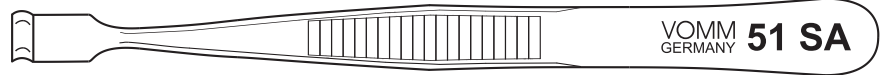
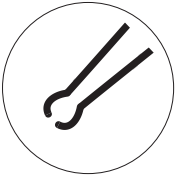

51 SA

2148

10,78 €

6.5 mm breite Spitze, Aufnahme \varnothing 1.5mm

6.5 mm wide tips, \varnothing 1.5 mm

120 mm

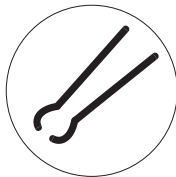

No Nickel-Allergy!

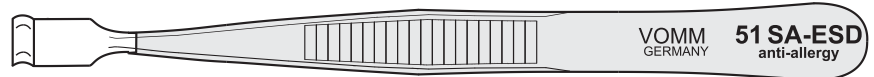

51 SA-ESD

3621

10,68 €

Wie 51 SA, jedoch ESD-beschichtet

Same as 51 SA, but ESD-coated

120 mm

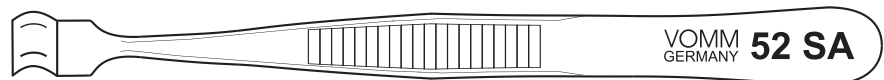
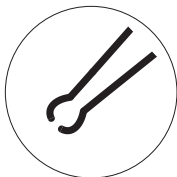

52 SA

2149

10,78 €

6.5 mm breite Spitze, Aufnahme \varnothing 3.5 mm

6.5 mm wide tips, \varnothing 3.5 mm

120 mm

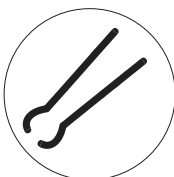

No Nickel-Allergy!

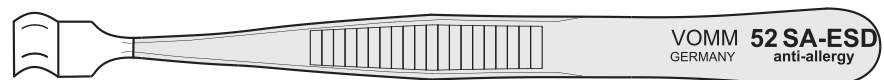

52 SA-ESD

3622

10,68 €

Wie 52 SA, jedoch ESD-beschichtet

Same as 52 SA, but ESD-coated

120 mm



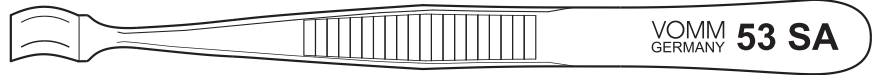
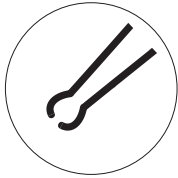

53 SA 2150 **10,78 €**

6.5 mm breite Spitze, Aufnahme \varnothing 6.5 mm
 6.5 mm wide tips, \varnothing 6.5 mm

120 mm

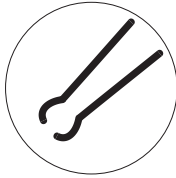

No Nickel-Allergy!

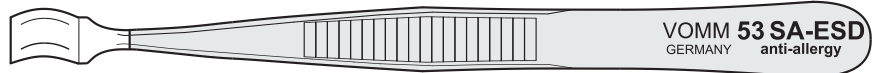

53 SA-ESD 3626 **10,68 €**

Wie 53 SA, jedoch ESD-beschichtet
 Same as 53 SA, but ESD-coated

120 mm

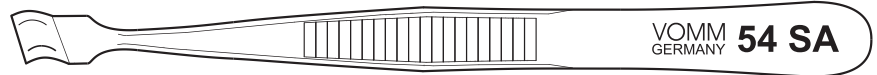
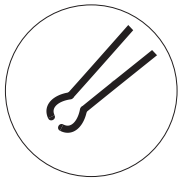

54 SA 2146 **10,78 €**

6.5 mm breite Spitze, diagonale Aufnahme \varnothing 3.5 mm
 6.5 mm wide tips, \varnothing 3.5 mm diagonal

120 mm

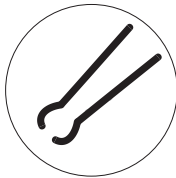

No Nickel-Allergy!



54 SA-ESD 3623 **10,68 €**

Wie 54 SA, jedoch ESD-beschichtet
 Same as 54 SA, but ESD-coated

120 mm

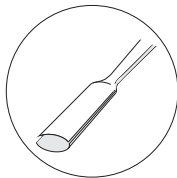

55 SA 2155 **10,78 €**

Aufnahme \varnothing 2.0 mm
 \varnothing 2.0 mm

120 mm



56 SA 2151 **10,78 €**

Spitze 3 mm breit, flach
 3 mm wide tips, flat

120 mm

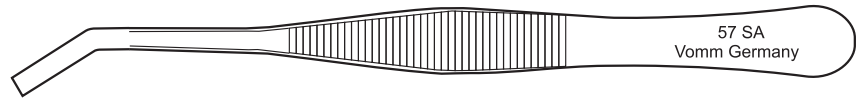
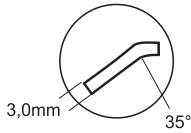

57 SA

2152

11,24 €

Wie 56 SA, 3mm breit, 35° gebogen

Same as 56 SA, 3mm wide, 35° bent

120 mm

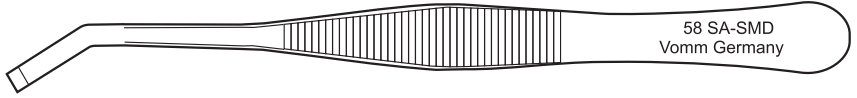
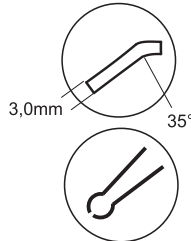

58 SA-SMD

2142

11,70 €

∅ 0.8 mm, 3mm breit, 35° gebogen

∅ 0.8 mm, 3mm wide, 35° bent

117 mm

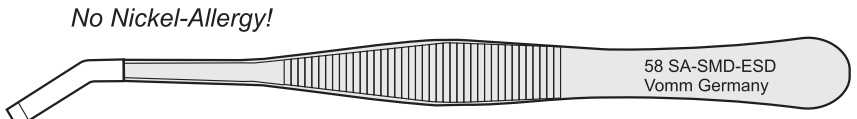
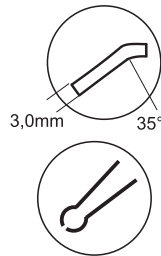

No Nickel-Allergy!



58 SA-SMD-ESD

3614

11,50 €

Wie 58 SA-SMD, jedoch ESD-beschichtet

Same as 58 SA-SMD, but ESD-coated

117 mm

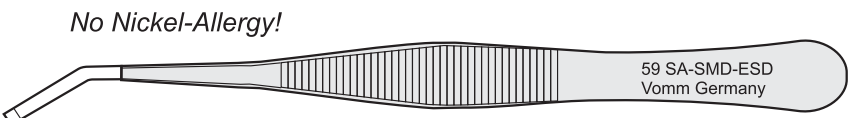
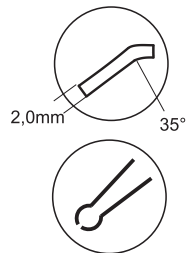

No Nickel-Allergy!



59 SA-SMD

2143

10,98 €

∅ 0.8 mm, 2mm breit, 35° gebogen

∅ 0.8 mm, 2mm wide, 35° bent

117 mm

59 SA-SMD-ESD

3603

11,50€

Wie 59 SA-SMD, jedoch ESD-beschichtet Same as 59 SA-SMD, but ESD-coated

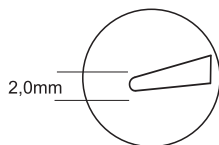

112 SA

9215

14,10 €

Stumpfe Leichtpinzette, sehr dünn

Blunt Light Tweezer, very thin

100 mm

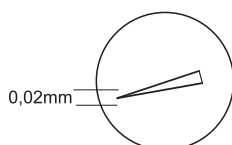

113 SA

9220

14,84 €

Spitze Leichtpinzette, sehr dünn

Pointed Light Tweezer, very thin

114 SA

9221

21,36 €

Sporenpinzette microfeine Spitze

Tweezer for picking up spores Microfine tips

100 mm

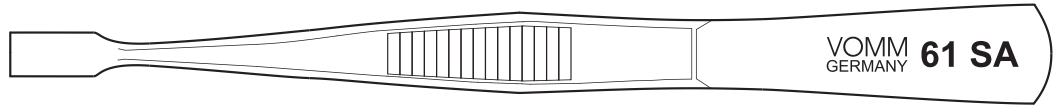
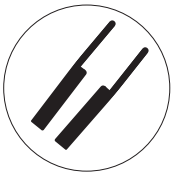

Wärmeableitpinzette mit Kupferbesatz

61 SA

3412

16,64 €

Heat-sinking Tweezer with copper-plated tips

145 mm

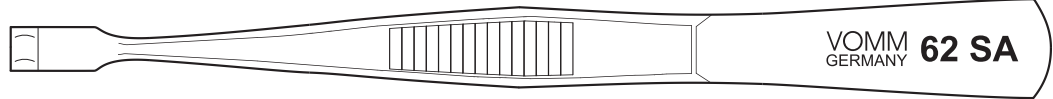
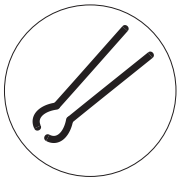

∅ 3,5 mm

62 SA

3416

12,74 €

∅ 3,5 mm

145 mm

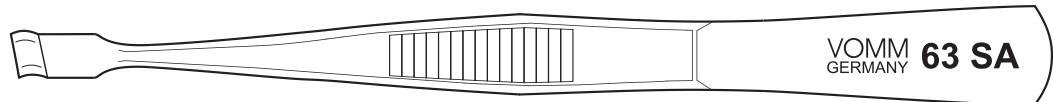
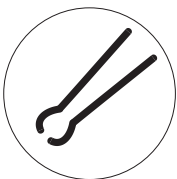

∅ 3,5 mm, diagonal

63 SA

3419

12,74 €

∅ 3,5 mm, diagonal

145 mm

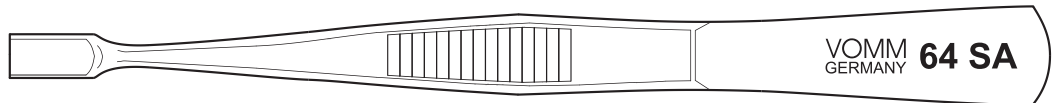
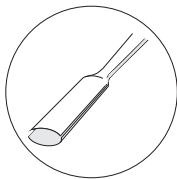

∅ 3,5 mm

64 SA

3414

12,74 €

∅ 3,5 mm

145 mm

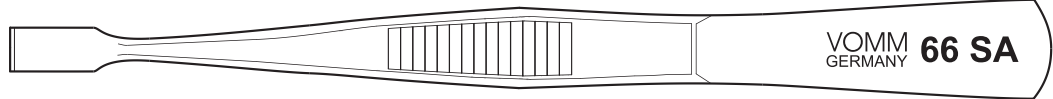
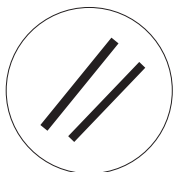

66 SA

3418

12,74 €

flach

flat

145 mm

66b SA

3411

19,96 €

gebogen

bent

145 mm

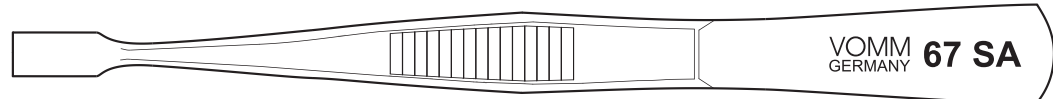
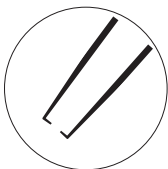

winklig

67 SA

3417

12,74 €

bent

145 mm

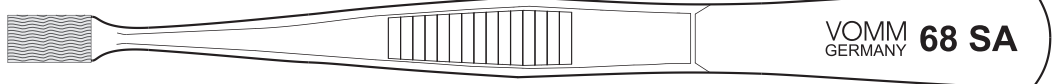
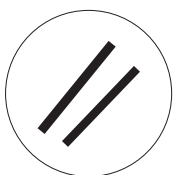

Spitze mit Silikon-Schutz

68 SA

3413

16,48 €

Silicone covered tips

145 mm

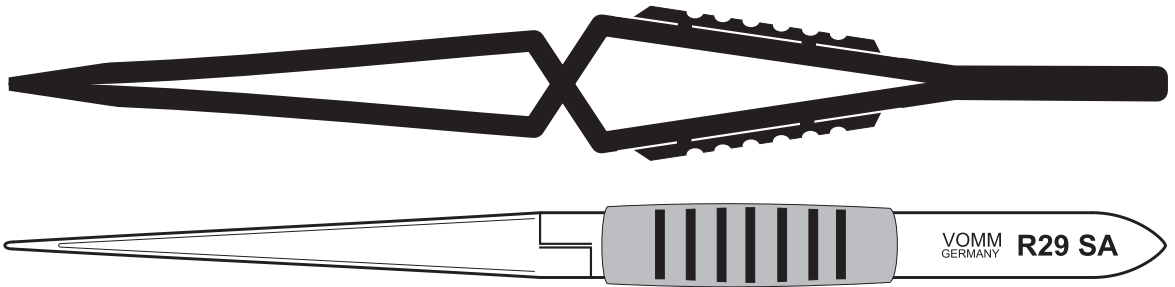

R29	3272	10,94 €	vernickelt	<i>nickel-plated</i>	160 mm
R29 SA	3270	12,90 €	Rostfrei, antimagnetisch	<i>stainless, antimagnetic</i>	160 mm

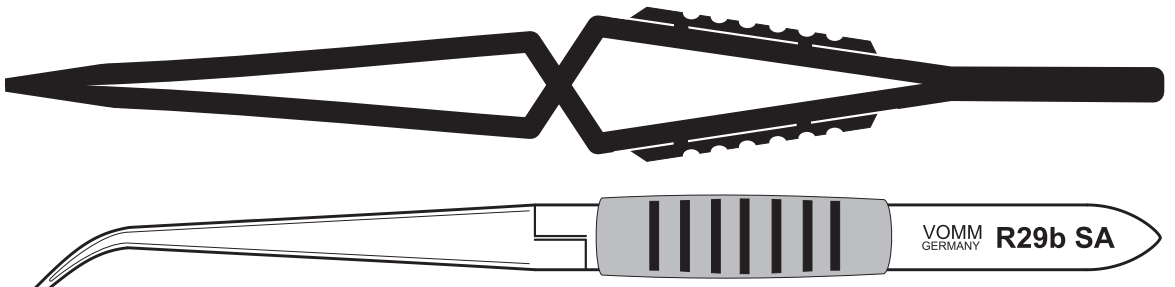

R29b	3273	11,70 €	vernickelt	<i>nickel-plated</i>	160 mm
R29b SA	3271	13,64 €	Rostfrei, antimagnetisch	<i>stainless, antimagnetic</i>	160 mm
R29b SA-T	3276	21,80 €	Wie R29b SA jedoch ganz Teflon beschichtet	<i>Same as R29b SA, but coated with Teflon</i>	160 mm

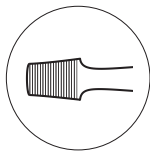
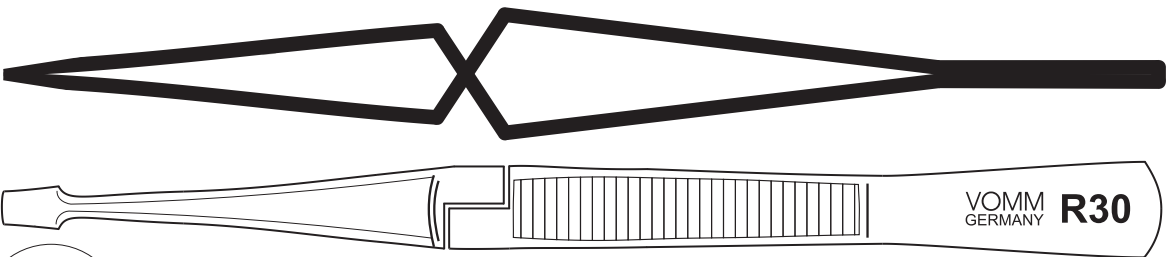

R30	8075	10,50 €	vernickelt, Spitze fein gezahnt	<i>nickel-plated, with fine serration</i>	160 mm
------------	------	----------------	---------------------------------	---	--------

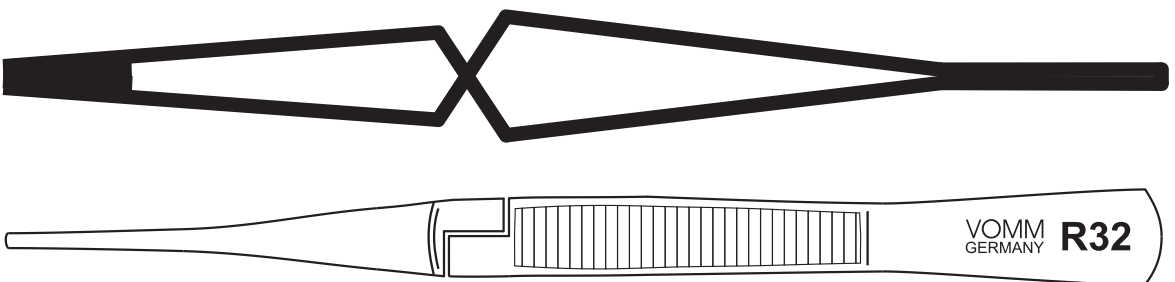

R32	3275	16,34 €	Wärmeableit-Kreuzpinzette, vernickelt <i>Heat-sinking, reversible Tweezer, nickel-plated</i>		160 mm
------------	------	----------------	---	--	--------

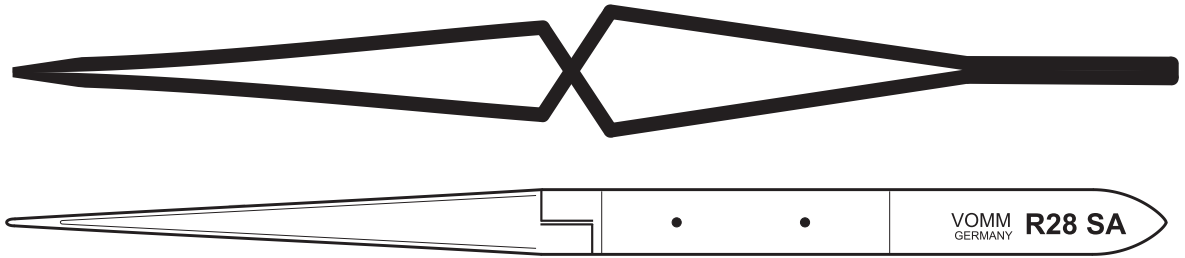

R28 SA 3274 **10,24 €** Rostfrei, antimagnetisch Preisgünstige Ausführung 160 mm
stainless, antimagnetic Low-cost, nickel-plated

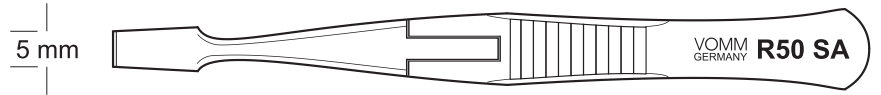

R50 SA 8050 **16,04 €** Deckglaspinzette Cover-Glass Tweezer 105 mm
R50b SA 8051 **17,80 €** dto., gebogen same, bent 105 mm

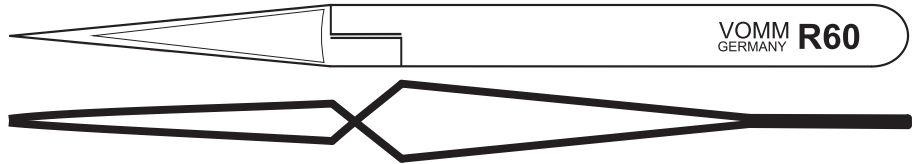

R60 8060 **10,78 €** vernickelt, selbstklemmend Nickel-plated, reversible function 120 mm
R61 8061 **11,86 €** Wie R60, jedoch länger Same as R60, but longer 160 mm

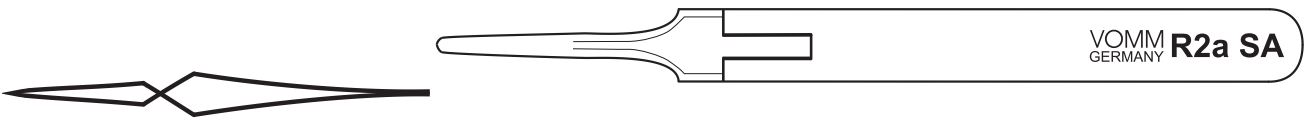

R2a SA 5802 **14,70 €** Wie 2a SA, jedoch als durchgesteckte Kreuzpinzette
Same as 2a SA, but self-locking and box-joint 115 mm



R3 SA 5803 **14,70 €** Wie 3 SA, jedoch als durchgesteckte Kreuzpinzette
Same as 3 SA, but self-locking and box-joint 115 mm

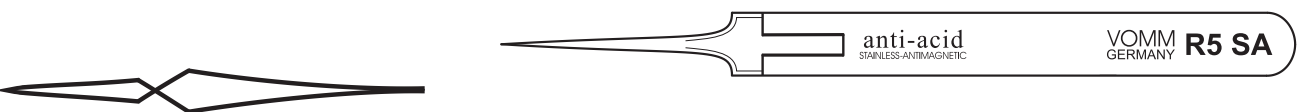

R5 SA 5805 **14,70 €** Wie 5 SA, jedoch als durchgesteckte Kreuzpinzette
Same as 5 SA, but self-locking and box-joint 105 mm



R7a SA 5807 **17,66 €** Wie 7a SA, jedoch als durchgesteckte Kreuzpinzette
Same as 7a SA, but self-locking and box-joint 115 mm

auch einzeln erhältlich, siehe B.-Nr. und Einzelpreis

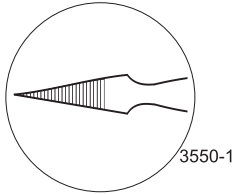

Spitzen aus 3550-2
KERAMIK
Ceramic Tips

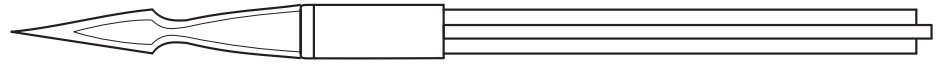

100,48 €

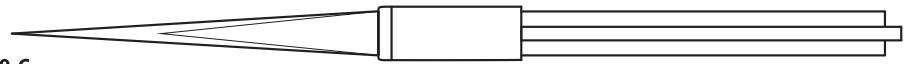

105,70 €

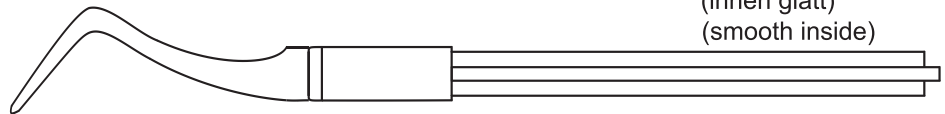

(innen glatt)
 (smooth inside)

119,82 €

CERAMset 3550 **266,52 €** Satz von 3 versch. Keramikpinzetten mit Kunststoffgriff
Set of 3 different Ceramic Tweezers with handles made of Polyacetal 130 mm

Massive

KERAMIK

Solid Ceramic



Original **VOMM**
 FINE CERAMIC TWEEZER

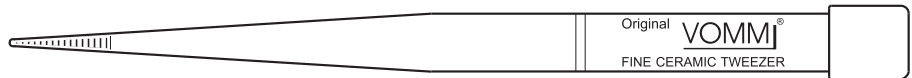

Original **VOMM**
 FINE CERAMIC TWEEZER

AA CER 8502 **78,22 €** Spitze 1 mm breit, glatt *Tips 1 mm width, smooth* 125 mm
PSF CER 8501 **78,22 €** Wie AA CER, jedoch gezahnt *Same as AA CER, but serrated* 125 mm

Massive

KERAMIK

Solid Ceramic

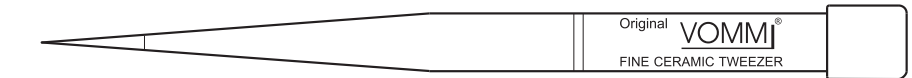

Original **VOMM**
 FINE CERAMIC TWEEZER

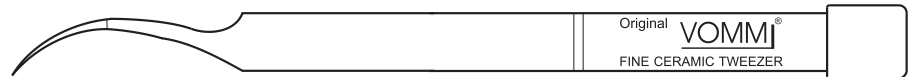

Original **VOMM**
 FINE CERAMIC TWEEZER

3 CER 8503 **91,98 €** sehr spitz, glatt *very pointed, smooth* 120 mm
7a CER 8507 **98,86 €** Spitz, gebogen *Pointed, bent* 125 mm

Klingen aus

KERAMIK

Ceramic Blades

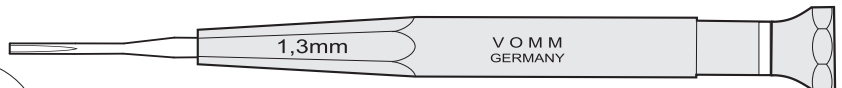
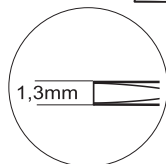

Antistatisch-schwarz
Antistatic-black

TRIM 09 6409-A **19,78 €** 0.9 x 0.4 x 30 mm 110 mm
TRIM 13 6413-A **19,78 €** 1.3 x 0.4 x 30 mm 110 mm
TRIM 18 6418-A **19,78 €** 1.8 x 0.4 x 30 mm 110 mm
TRIM 30 6430-A **19,78 €** 3.0 x 0.4 x 30 mm 110 mm
TRIM 0 6401-A **24,26 €** Philips 0 110 mm
TRIM 1 6402-A **24,26 €** Philips 0 special 110 mm

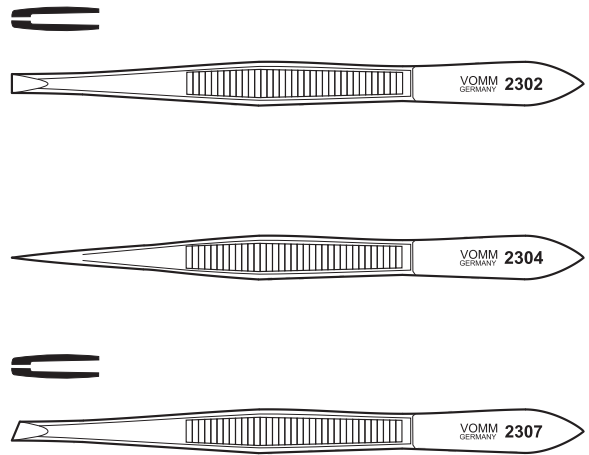
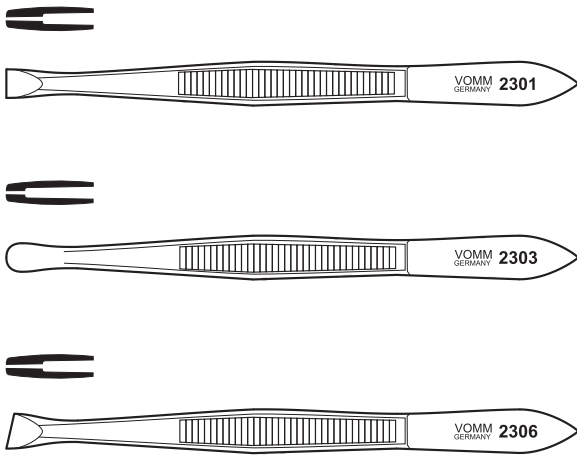

2301	7,82 €	Rostfreier Stahl
2302	7,82 €	dito
2303	7,82 €	dito
2304	7,82 €	dito
2306	7,82 €	dito
2307	7,82 €	dito

<i>Stainless Steel</i>	2301	80 mm
<i>same</i>	2302	80 mm
<i>same</i>	2303	80 mm
<i>same</i>	2304	80 mm
<i>same</i>	2306	80 mm
<i>same</i>	2307	80 mm

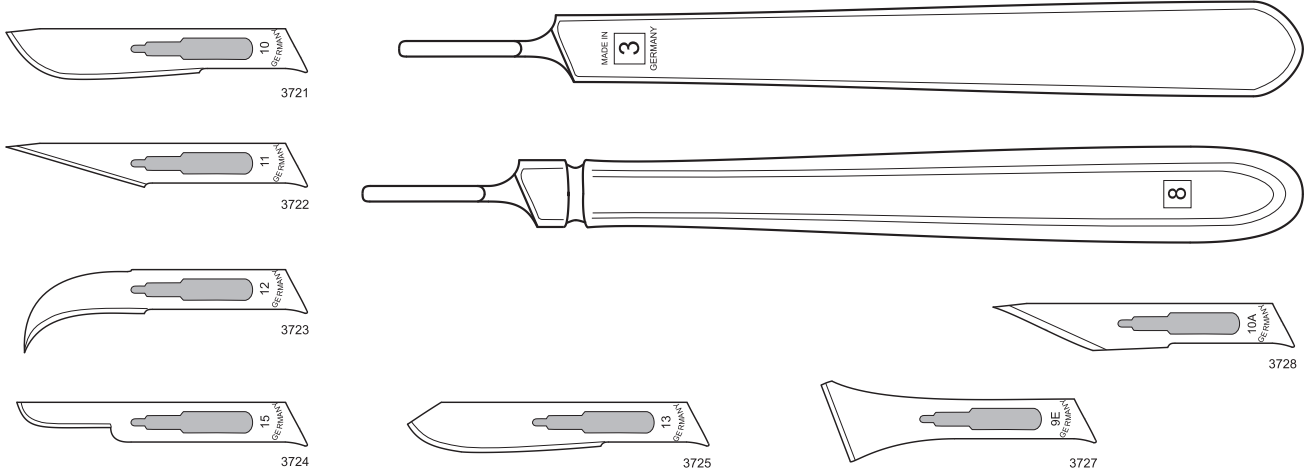

3	3730	6,34 €	Standard-Skalpellgriff, verchromt	<i>Scalpel-Handle, chrome-plated</i>	124 mm
8	3719	30,84 €	Hohlheft-Skalpellgriff	<i>Hollow Scalpel-Handle</i>	129 mm
	3721-3728	0,76 €	Skalpellklingen (Preis/Stück)	<i>Scalpel-Blades (price/piece)</i>	

Klingen 5950 **4,52 €** Paar von Ø 0,2mm bis Ø 1,2mm *Blades - Pair - from Ø 0,2mm up to Ø 1,2mm*

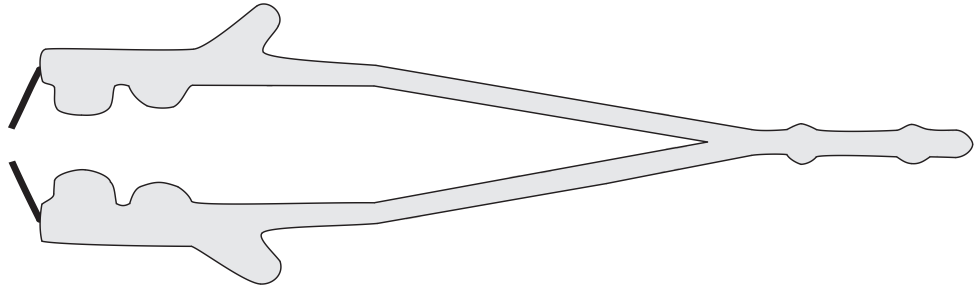

Lackabkratzer für isolierte Drähte
Wire-Scraper

WS2 6000 **18,72 €** 130 mm

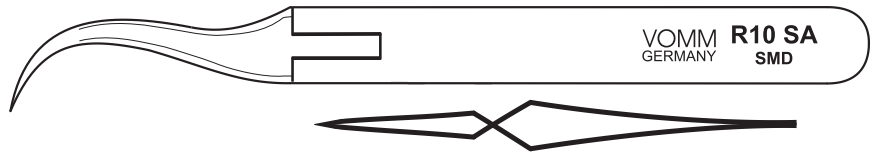

Für SMD-Chips, durchgesteckt und selbstklemmend
For SMT-Chips, reversible-function and box-joint

6610 **25,52 €** **R10 SA-SMD** 117 mm

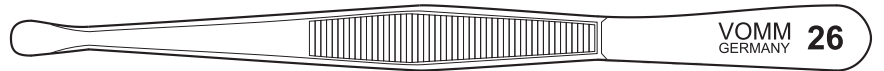

Runde, dünne Spitzen
Round and flat tips

26 3350 **5,86 €** 120 mm

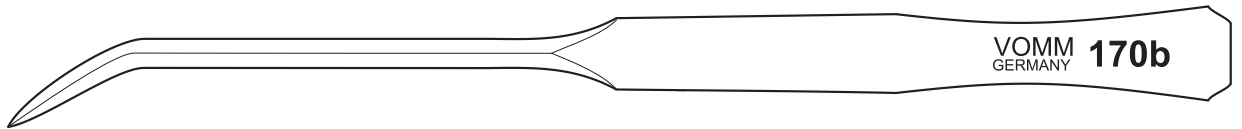

170	3280	10,64 €	vernickelt, gerade	<i>Nickel-plated, straight</i>	170 mm
170b	3281	11,24 €	dto., gebogen	<i>same, but bent</i>	170 mm



80	9551	3,92 €	Blechipzette, vernickelt	<i>Low-Cost, nickel-plated</i>	120 mm
81	9552	4,52 €	Wie 80, nur länger	<i>Same as 80, but longer</i>	140 mm
82	9553	4,98 €	Wie 80, nur länger	<i>Same as 80, but longer</i>	160 mm

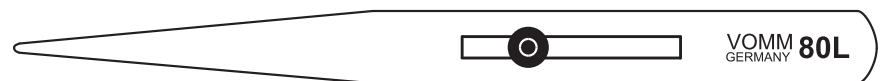

80L	9366	7,50 €	Mit Feststellschieber, vernickelt	<i>With Slide-Lock, nickel-plated</i>	120 mm
82L	9367	8,70 €	Wie 80L, nur länger	<i>Same as 80L, but longer</i>	160 mm

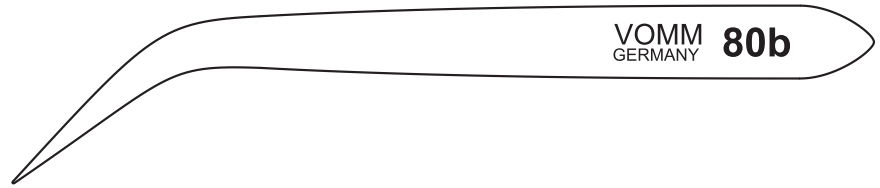

80b	8000	4,98 €	Vernickelt	<i>Nickel-plated</i>	120 mm
------------	------	---------------	------------	----------------------	--------



Abb. vergrößert

D11	9710	7,50 €	Vernickelt	<i>Nickel-plated</i>	120 mm
D12	9712	8,24 €	Vernickelt	<i>Nickel-plated</i>	140 mm
D13	9714	10,18 €	Vernickelt	<i>Nickel-plated</i>	160 mm
D11 S	9711	9,30 €	Wie D11, jedoch rostfrei	<i>Same as D11, but Stainless</i>	120 mm
D12 S	9713	10,50 €	Wie D12, jedoch rostfrei	<i>Same as D12, but Stainless</i>	140 mm
D13 S	9716	10,94 €	Wie D13, jedoch rostfrei	<i>Same as D13, but Stainless</i>	160 mm
D13 SA	9709	11,70 €	Wie D13 S, jedoch antimagnetisch	<i>Same as D13 S, but antimagnetic</i>	160 mm

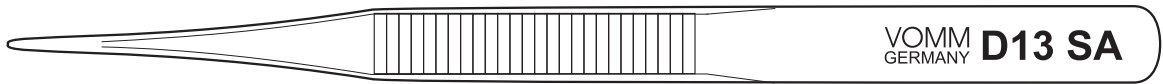

Abb. vergrößert

D21	9717	7,50 €	Vernickelt	<i>Nickel-plated</i>	120 mm
D22	9719	8,24 €	Vernickelt	<i>Nickel-plated</i>	140 mm
D23	9721	10,36 €	Vernickelt	<i>Nickel-plated</i>	160 mm
D21 S	9718	9,16 €	Wie D21, jedoch rostfrei	<i>Same as D21, but Stainless</i>	120 mm
D22 S	9720	10,36 €	Wie D22, jedoch rostfrei	<i>Same as D22, but Stainless</i>	140 mm
D23 S	9722	10,94 €	Wie D23, jedoch rostfrei	<i>Same as D23, but Stainless</i>	160 mm



D3	9723	9,00 €	Sehr spitz, vernickelt	<i>Very pointed, nickel-plated</i>	140 mm
D3 S	9724	11,10 €	Wie D3, jedoch rostfrei	<i>Same as D3, but Stainless</i>	140 mm

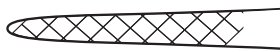
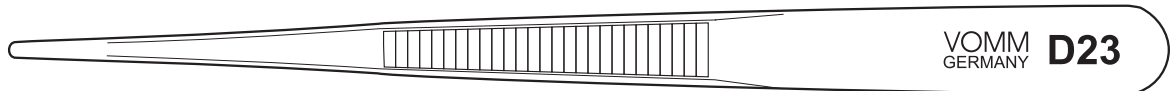
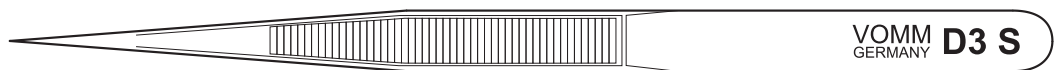
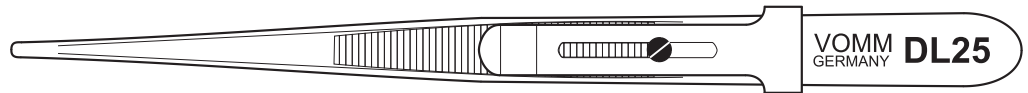
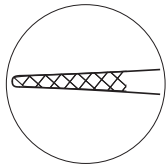

DL15	9715	19,58 €	Mit Feststellschieber, vernickelt	<i>With Slide-Lock, nickel-plated</i>	160 mm
DL25	9725	18,48 €	Wie DL15, nur kürzer	<i>Same as DL15, but shorter</i>	140 mm



19 SA-SMD	6619	14,76 €	Mit Einfräsung, $\varnothing 0,5\text{mm}$	<i>With milled slot, $\varnothing 0,5\text{ mm}$</i>	120 mm
------------------	------	----------------	--	---	--------



D	6500	12,74 €	Schneidepinzette	<i>Cutting-Tweezer</i>	95 mm
----------	------	----------------	------------------	------------------------	-------

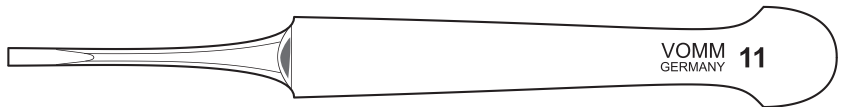

Glatte Greiffläche



11	8600	10,50 €	Vernickelt	<i>Nickel-plated</i>	115 mm
-----------	------	----------------	------------	----------------------	--------

Glatte Greiffläche

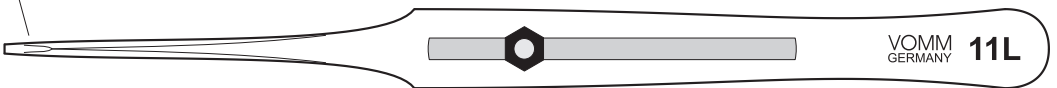

11L	8610	17,24 €	Mit Feststellschieber, vernickelt	<i>With slide-lock, nickel-plated</i>	145 mm
------------	------	----------------	-----------------------------------	---------------------------------------	--------

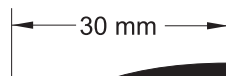

110 SA	9210	15,30 €	Wägepinzette, Spitze aus Kunststoff	<i>Weight Tweezer, Plastic Tips</i>	95 mm
---------------	------	----------------	-------------------------------------	-------------------------------------	-------



0450 **10,36 €** Kunststoffgriff, Spiegel Ø14 mm *Plastic handle, mirror Ø 14 mm* 165 mm

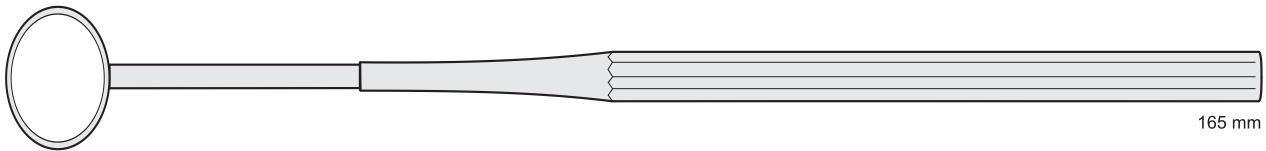

0455 **14,48 €** Rostfreier Griff, Spiegel Ø20 mm *Stainless Steel handle, mirror Ø20 mm*

0456 **8,52 €** Griff Vernickelt, Spiegel Rostfrei Ø20 mm
Nickel-plated handle, Stainless steel mirror Ø 20 mm

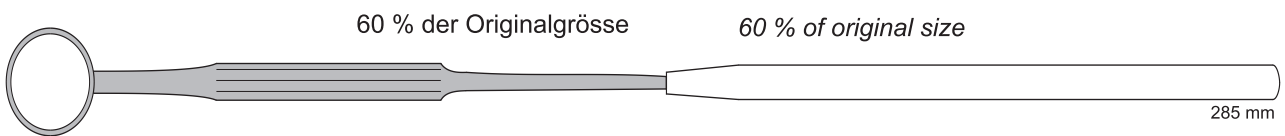

0460 **11,70 €** Kunststoff, 2-teiliger Griff, Spiegel Ø18 mm *Plastic, handle consists of 2 parts, mirror Ø18 mm*

0466 **52,56 €** Vernickelt, Teleskopgriff, Spiegel Ø 18 mm und verstellbar
Nickel-plated, telescope-handle, adjustable mirror Ø18 mm

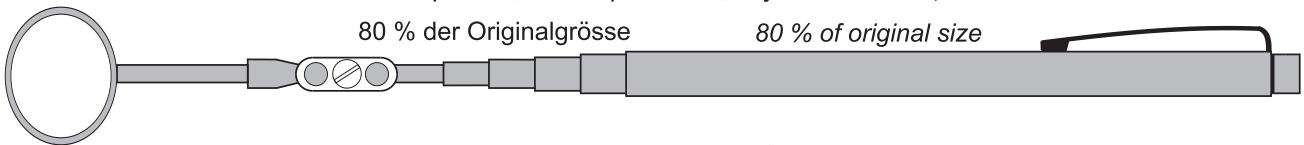

0468 **67,98 €** Vernickelt, Teleskopgriff, Spiegel Ø 60 mm und verstellbar
Nickel-plated, telescope-handle, adjustable mirror Ø 60 mm 10 -300 mm

Griffe können individuell bestückt werden
85 % der Originalgrösse

Handles can be equipped individually
85 % of original size

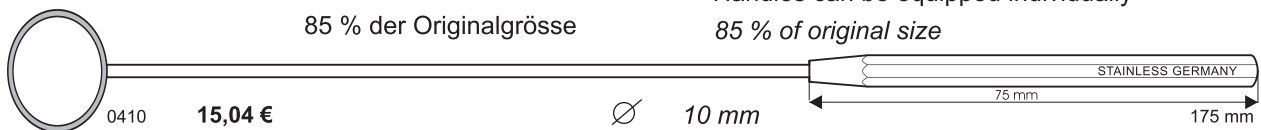

0410	15,04 €	Ø 10 mm	175 mm
0414	16,52 €	Ø 14 mm	180 mm
0416	16,52 €	Ø 16 mm	180 mm
0418	16,52 €	Ø 18 mm	180 mm
0420	14,06 €	Ø 20 mm	180 mm
0422	14,06 €	Ø 22 mm	180 mm
0424	14,06 €	Ø 24 mm	180 mm
0426	14,06 €	Ø 26 mm	185 mm
0428	16,52 €	Ø 28 mm	190 mm
0430	16,52 €	Ø 30 mm	190 mm

Kehlkopfspiegel

Gesamtlängen

Laryngoscopes

Total Lengths

Haken, Sonden, Excavatoren, Typ Dental, aus rostfreiem Stahl gehärtet für Arbeiten auf Leiterplatten, zum Modellieren

Hooks, probes and excavators, dental type, made of stainless steel hardened for works on PCB's, modelling

9-11



1-07

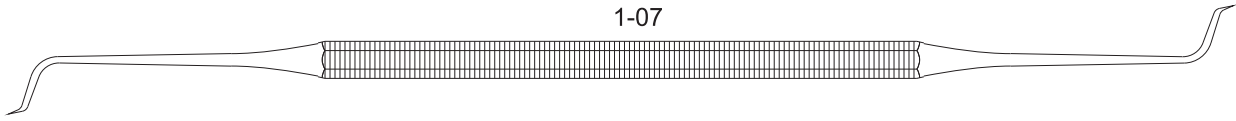

2-06

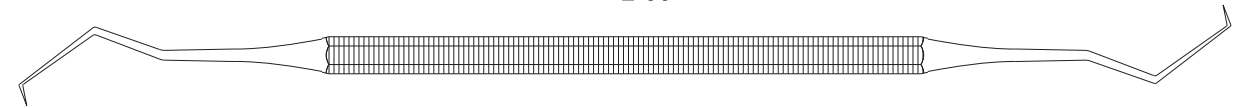

3-05

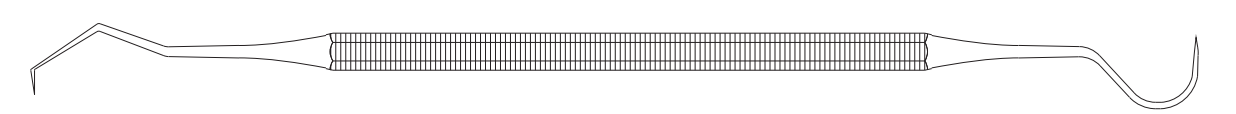

4-16

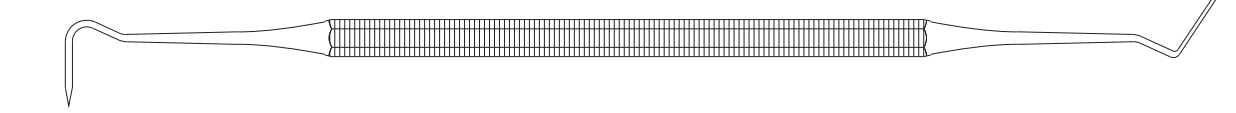

5-09

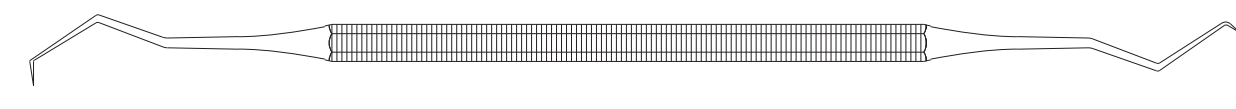

6-10

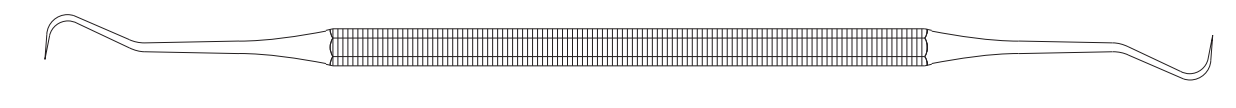

7-17

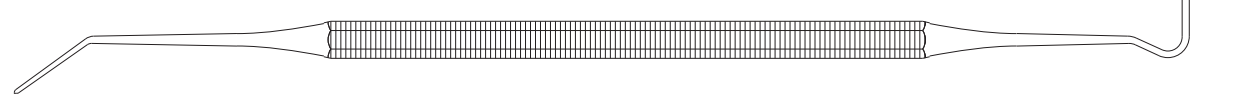

8-02

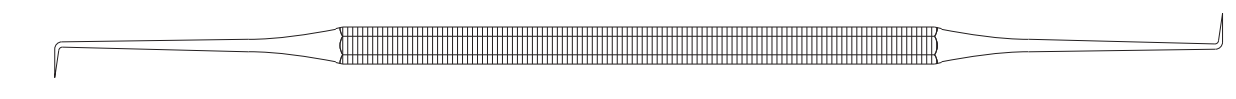

Sonden, 9-teiliger Satz, zum Hebeln und Entfernen von Bauteilen
Modelle sind auch einzeln erhältlich (Art.-Nr. 3220 + Haken-Nr.)

Preis/Satz:
Price/set: **118,40 €**

Art.-Nr. 3220

Preis/Stück: *Set of 9 probes, for levering and removing components*
Price/piece: **13,80 €** *Models are also available separately (Art.-No. 3220 + hook no.)*

Haken, Sonden, Excavatoren, Typ Dental, aus rostfreiem Stahl gehärtet für Arbeiten auf Leiterplatten, zum Modellieren

Hooks, probes and excavators, dental type, made of stainless steel hardened for works on PCB's, modelling

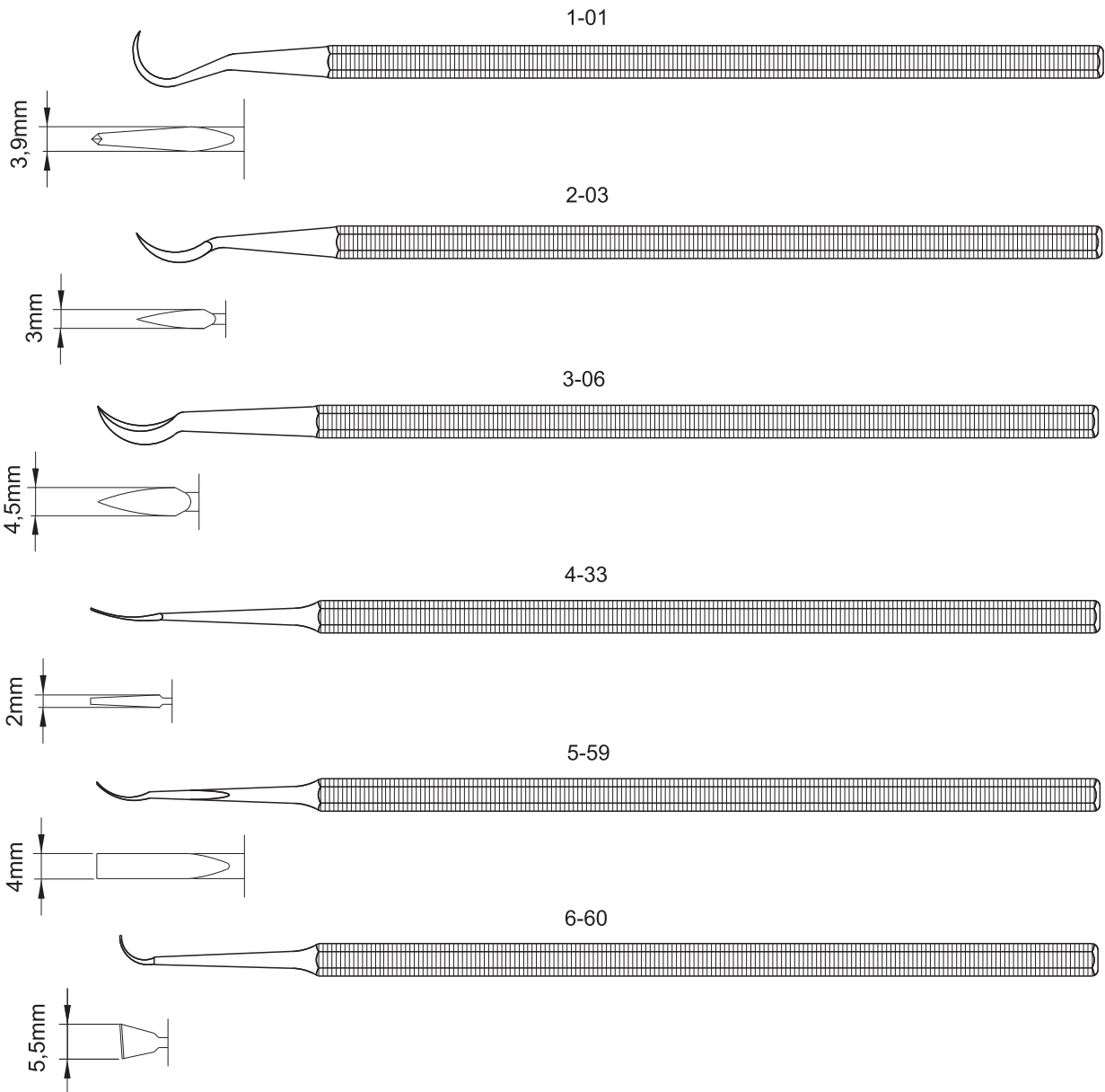

Art.-Nr. 3230

Haken, 6-teiliger Satz, scharf, für Leiterbahnen, zum Schneiden und Markieren.

Preis/Satz:

Haken sind auch einzeln erhältlich (Art.-Nr. 3230 + Haken-Nr.)

Price/set: **109,86 €**

Preis/Stück:

Set of 6 hooks, sharp, for printed conductors, for cutting and marking

Price/piece: **18,82 €**

Models are also available separately (Art.-No. 3230 + hook no.)

Mikrospatel



3240

10,36 €

Mikrospatel aus Chrom/Nickel-Edelstahl, löffelförmig, 4mm breit
Micro-spatula of Chrome/Nickel-Steel, spoon-shaped, 4mm wide

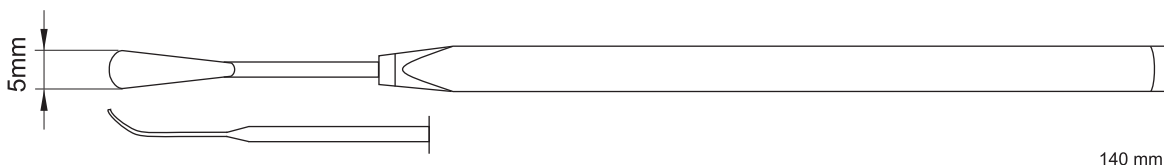

3241

10,36 €

Mikrospatel aus Chrom/Nickel-Edelstahl, löffelförmig, 5mm breit
Micro-spatula of Chrome/Nickel-Steel, spoon-shaped, 5mm wide

Sonderausführungen:
 universal verwendbare Teile

Special models:
 multi-purpose versatility

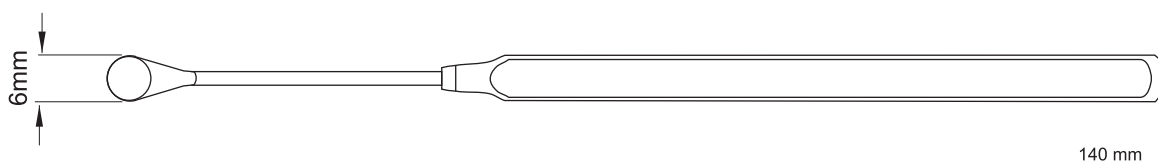

3245

12,50 €

Mikrolöffelchen aus Chrom/Nickel-Edelstahl, 5mm breit
Micro-spoon of Chrome/Nickel-Steel, 5mm wide

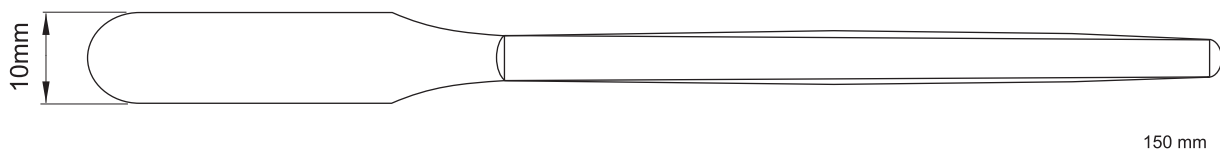

3254

12,50 €

Spatel aus Chrom/Nickel-Edelstahl, 10mm breit
Spatula of Chrome/Nickel-Steel, 10mm wide



3221

12,12 €

Löthaken aus Chrom/Nickel-Edelstahl, für Kabel und Drähte
Soldering hook of Chrome/Nickel-Steel for cables and wires

165 mm

Spezial: Microspatel

sehr leichte Ausführung/ präzise arbeitend

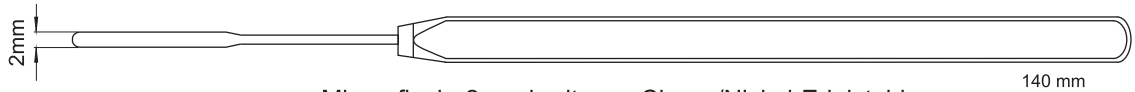

3250

12,12 €

Micro, flach, 2mm breit, aus Chrom/Nickel-Edelstahl

Micro, flat, 2mm wide, of Chrome/Nickel-Steel

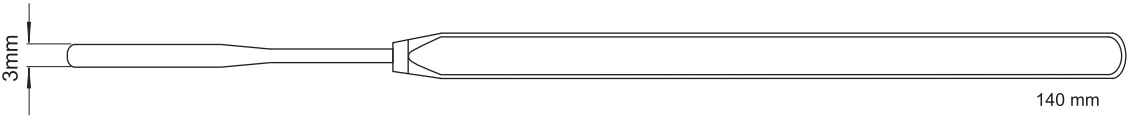

3251

12,12 €

Micro, flach, 3mm breit, aus Chrom/Nickel-Edelstahl

Micro, flat, 3mm wide, of Chrome/Nickel-Steel

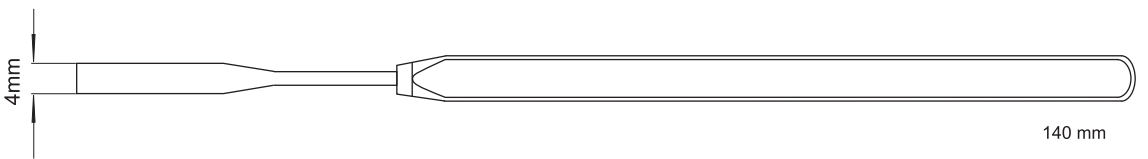

3252

12,12 €

Micro, flach, 4mm breit, aus Chrom/Nickel-Edelstahl

Micro, flat, 4mm wide, of Chrome/Nickel-Steel



3253

12,12 €

Micro, flach, 5mm breit, aus Chrom/Nickel-Edelstahl

Micro, flat, 5mm wide, of Chrome/Nickel-Steel

Pulverspatel winklige Ausführung, längs hohlgeformt

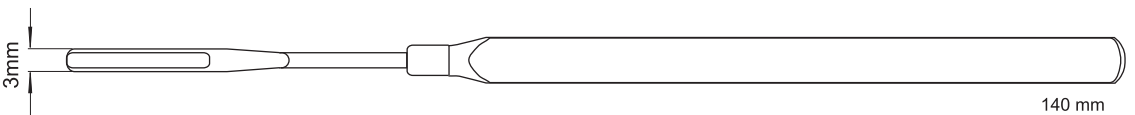

3260

13,26 €

Micro, winklig, hohl, 3mm breit, aus Chrom/Nickel-Edelstahl

Micro, twisty, concave, 3mm wide, of Chrome/Nickel-Steel

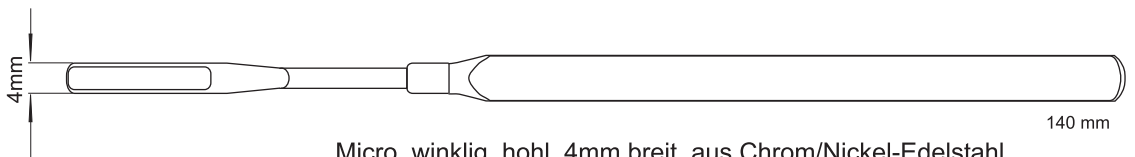

3261

13,26 €

Micro, winklig, hohl, 4mm breit, aus Chrom/Nickel-Edelstahl

Micro, twisty, concave, 4mm wide, of Chrome/Nickel-Steel

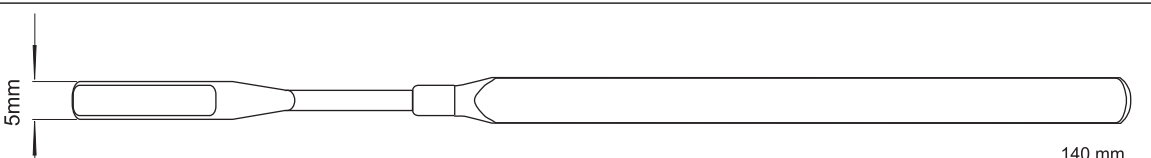

3262

13,26 €

Micro, winklig, hohl, 5mm breit, aus Chrom/Nickel-Edelstahl

Micro, twisty, concave, 5mm wide, of Chrome/Nickel-Steel

Langer Bogen 10mm
Long bent 10mm

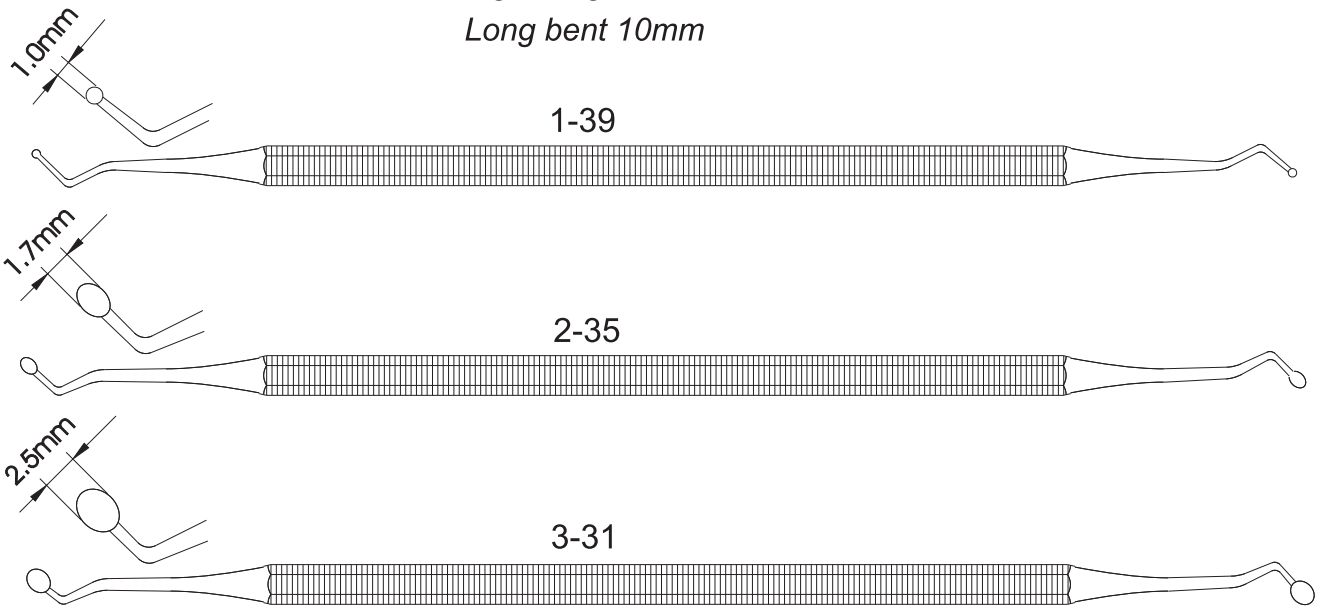

Kurzer Bogen 8mm
Short bent 8mm

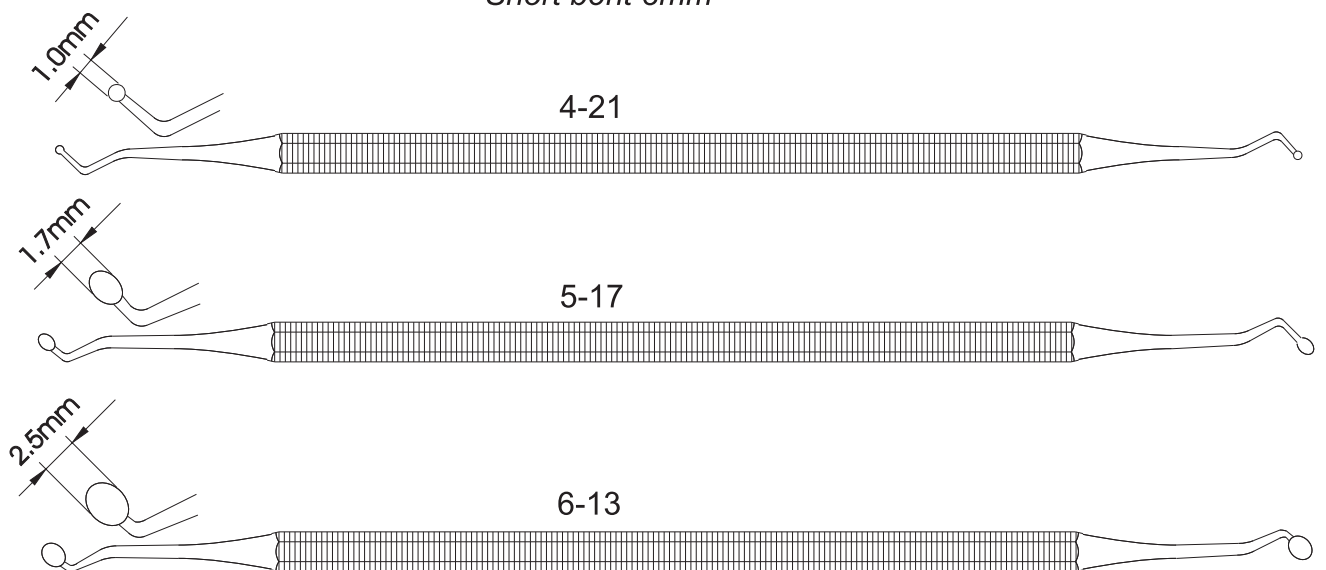

3225

Preis/Satz

Price/Set **108,70 €**

Excavatoren, aus rostfreiem Stahl gehärtet, 6-teiliger Satz, als Mini-Spatel verwendbar
Modelle sind auch einzeln erhältlich (Art.-Nr. + Spiegel-Nr.)

Preis/Stk.

Price/Piece **19,28 €**

Set of 6 excavators, of stainless steel hardened, can be used as mini-spatulas
Models are also available separately (Art.-No. + mirror-No.)

Nichtmetallische Handwerkzeuge

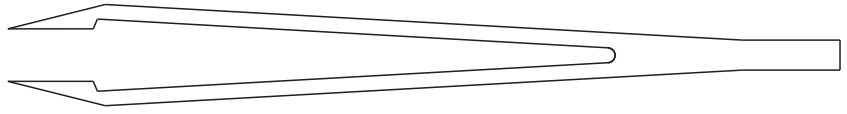
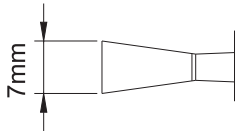

110mm
4 1/2 inch

03 5300 **6,90 €**

Dünne, 7mm breite Spitze, Delrin, glasfaserverstärkt
7mm wide, thin points, glass-filled Delrin

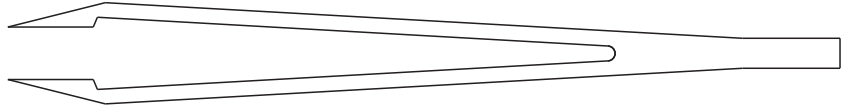
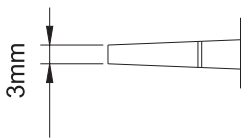

110mm
4 1/2 inch

100 5322 **5,34 €**

Dünne, flach-breite Spitze, 3mm breit, Delrin, glasfaserverstärkt
Thin tips, 3mm wide, glass-filled Delrin

100-AS 5323 **7,16 €**

Dito, jedoch aus leitfähiger CARBON-Faser
Same, but made of conductive Carbon Fibre

100-1 5324 **6,56 €**

Dito, jedoch aus linearem Polyethylen, säurefest
Same, but made of linear polyethylene, acid-resistant

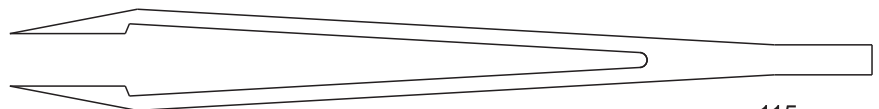
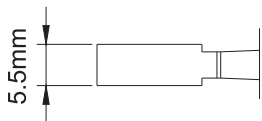

115mm
4 1/2 inch

04 5336 **6,28 €**

Dünne Spitze, 5,5mm breit, Delrin, glasfaserverstärkt
Flat points, 5,5mm wide, glass-filled Delrin

05 5338 **6,26 €**

7,5mm breit/wide

06 5302 **6,26 €**

9mm breit/wide

07 5304 **6,56 €**

12mm breit/wide



04-1 5337 **6,56 €**

Dito, jedoch aus säurebeständigem Polyethylen
Same, but made of acid-resistant Polyethylene

05-1 5339 **6,90 €**

7,5mm breit/wide

06-1 5303 **6,90 €**

9mm breit/wide

07-1 5305 **7,16 €**

12mm breit/wide



Nichtmetallische Handwerkzeuge

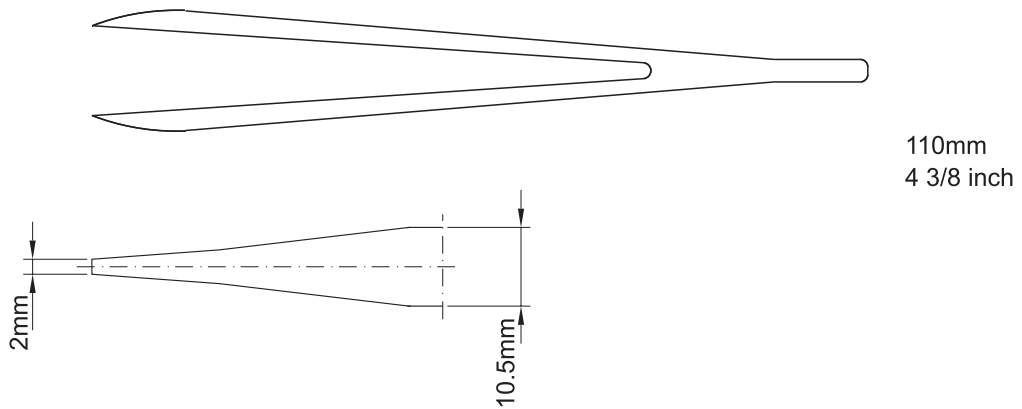

1A	5315	13,40 €	Starke Spitze, 3mm breit, CTFE, säurebeständig, 200°C <i>Strong points, 3mm wide, CTFE, acid-resistant, 200°C</i>
1A-1	5314	13,66 €	dito, jedoch mit Riefelung an den Innenspitzen <i>same, but with serrated points</i>

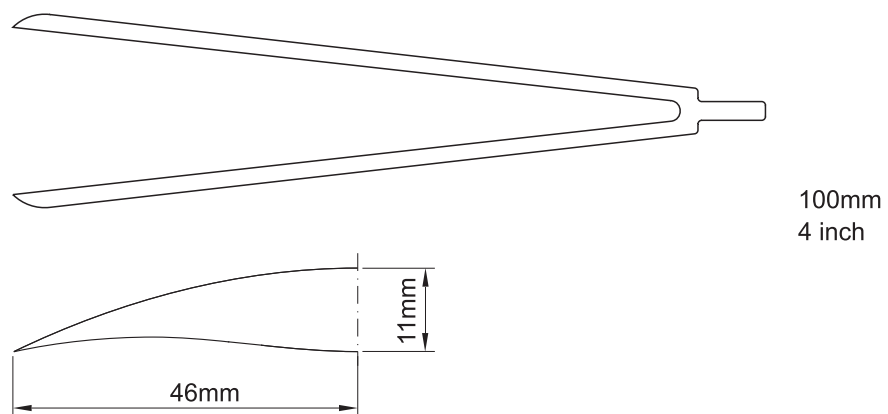

500	5328	6,56 €	Wägepinzette aus glasfaserverstärktem Delrin, sehr spitz <i>Weight Tweezer made of glass-filled Delrin, very pointed</i>
-----	------	---------------	---

Nichtmetallische Handwerkzeuge

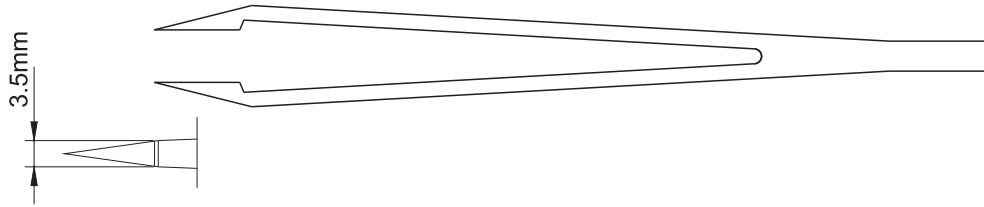

110mm
4 3/8inch

- | | | | |
|-------|------|---------------|--|
| 01 | 5310 | 5,68 € | Sehr feine Spitze, Delrin, glasfaserverstärkt
<i>Special superfine points, Delrin, glass-filled</i> |
| 01-AS | 5311 | 7,16 € | dito, jedoch aus leitfähiger CARBON-Faser
<i>Same, but made of conductive Carbon Fibre</i> |

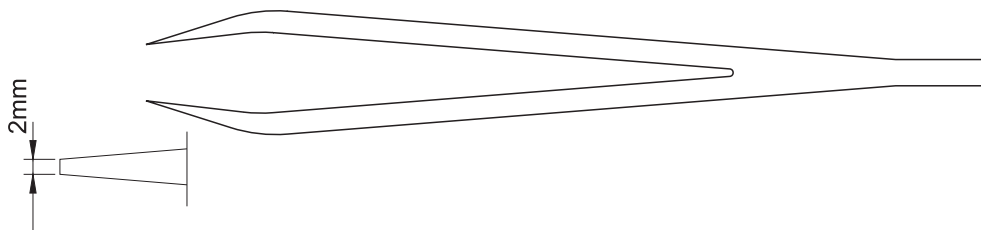

110mm
4 3/8inch

- | | | | |
|-----|------|---------------|---|
| 2aH | 5316 | 5,38 € | Flache, kräftige Spitze, 3mm breit, aus weichem Delrin, grün
<i>Flat, strong points, 3mm wide, made of softer Delrin</i> |
| 3aH | 5317 | 5,38 € | dito, jedoch aus Delrin, glasfaserverstärkt
<i>Same, but made of glass-filled Delrin</i> |

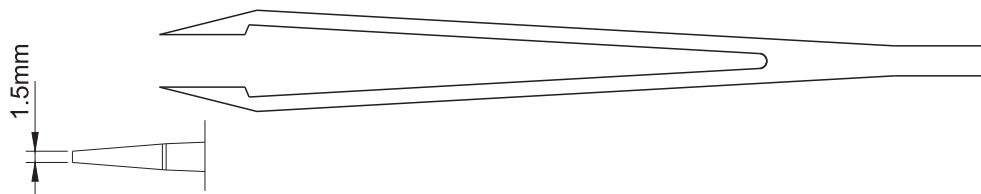

110mm
4 3/8inch

- | | | | |
|-------|------|---------------|--|
| 02 | 5334 | 5,38 € | Dünne, 1,5mm breite Spitze, Delrin, glasfaserverstärkt
<i>Flat points, 1mm wide, Delrin, glass-filled</i> |
| 02-AS | 5335 | 7,16 € | dito, jedoch aus leitfähiger CARBON-Faser
<i>Same, but made of conductive Carbon Fibre</i> |

Nichtmetallische Handwerkzeuge

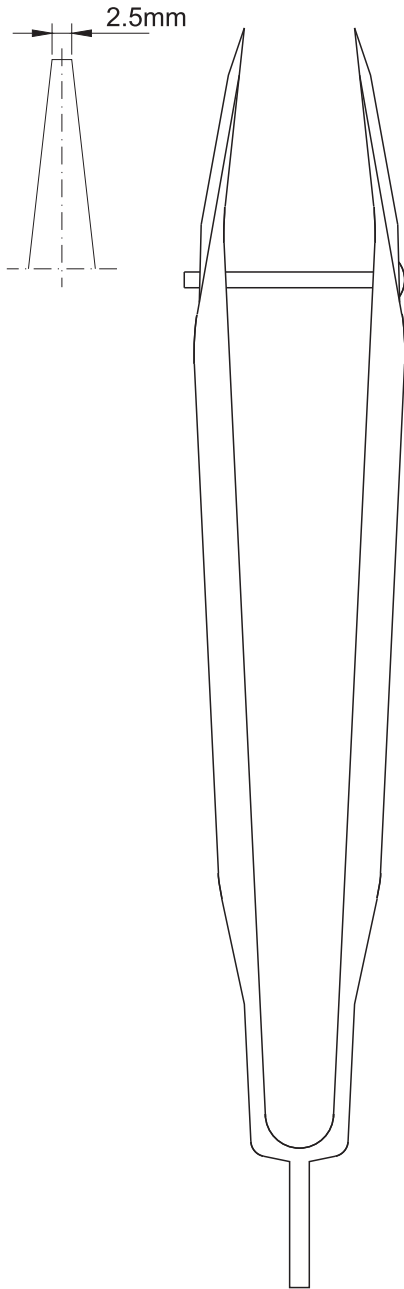

165mm
6 1/2inch

4a 5332 **18,64 €**
 2,5mm breite Spitze mit Führungsstift
 CTFE, säurebeständig, hitzebeständig bis 200°C
*2,5 wide points, with guide pin,
 CTFE, acid-resistant, heat-resistant up to 200°C*

5a 5330 **9,86 €**
 dito, jedoch aus glasfaserverstärktem
 Delrin
same, but made of glass-filled Delrin

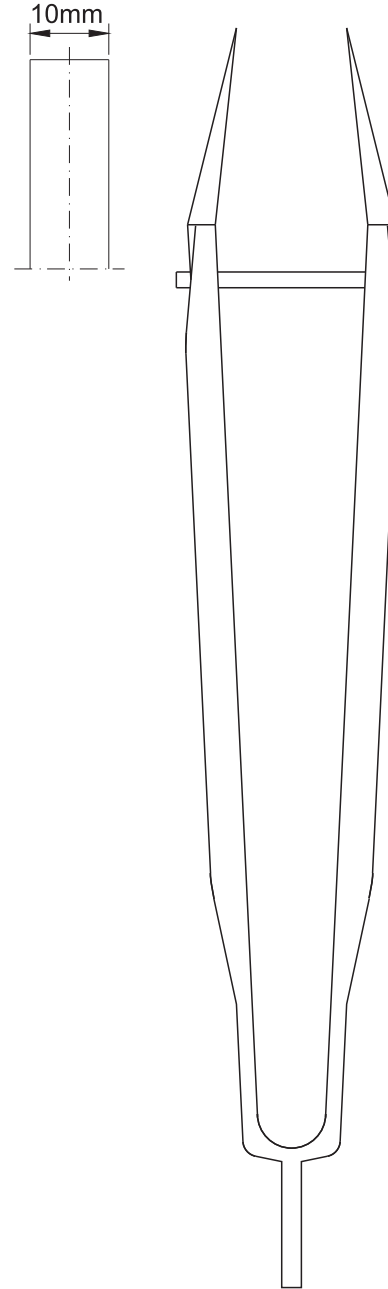

165mm
6 1/2inch

5a-1 5308 **10,12 €**
 Flache Spitze, 10mm breit, mit Führungs-
 stift, Delrin, glasfaserverstärkt
*Flat points, 10mm wide, with guide pin,
 glass-filled Delrin*

5a-2 5309 **10,42 €**
 dito, jedoch aus säuerbeständigem
 Polyethylen
*same, but made acid resistand linear
 Polyethylene*

Nichtmetallische Handwerkzeuge

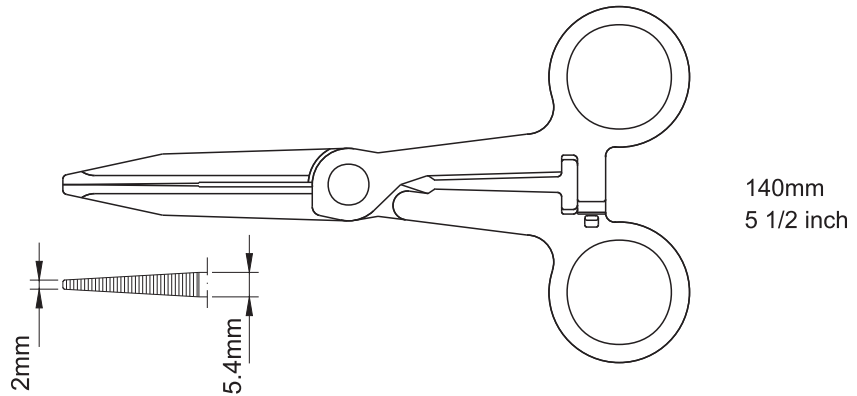

2700 **3,80 €** Nadelhalter aus Polyethylen, glasfaserverstärkt
Needle holder made of glass-filled Polyethylene

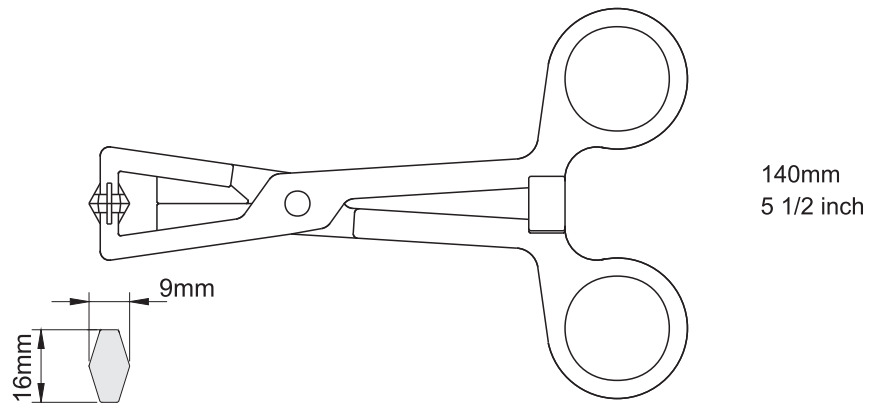

2701 **3,00 €** Schlauchklemme aus Polyethylen
Hose Clamping Forceps made of Polyethylene

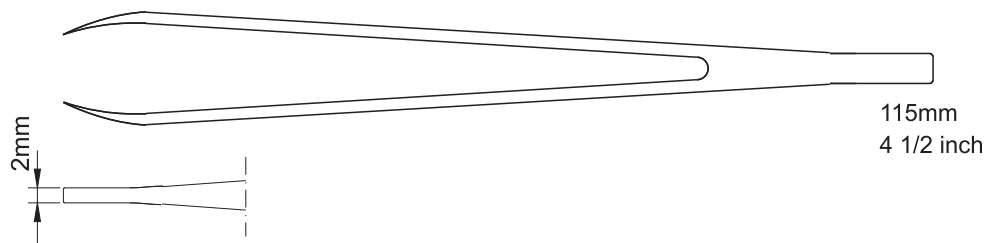

- | | | | |
|--------|------|---------------|--|
| 300 | 5320 | 5,38 € | Nur die vorderste Spitze fasst z.B. Wafer, Delrin glasfaserverstärkt
<i>Only the points grip e.g. Wafers, glass-filled Delrin</i> |
| 300-1 | 5318 | 5,38 € | Dito, jedoch aus weicherem grünen Delrin
<i>Same, but made of softer green Delrin</i> |
| 300-AS | 5321 | 7,16 € | Dito, jedoch aus leitfähiger CARBON-Faser
<i>Same, but made of conductive Carbon Fibre</i> |

Nichtmetallische Handwerkzeuge

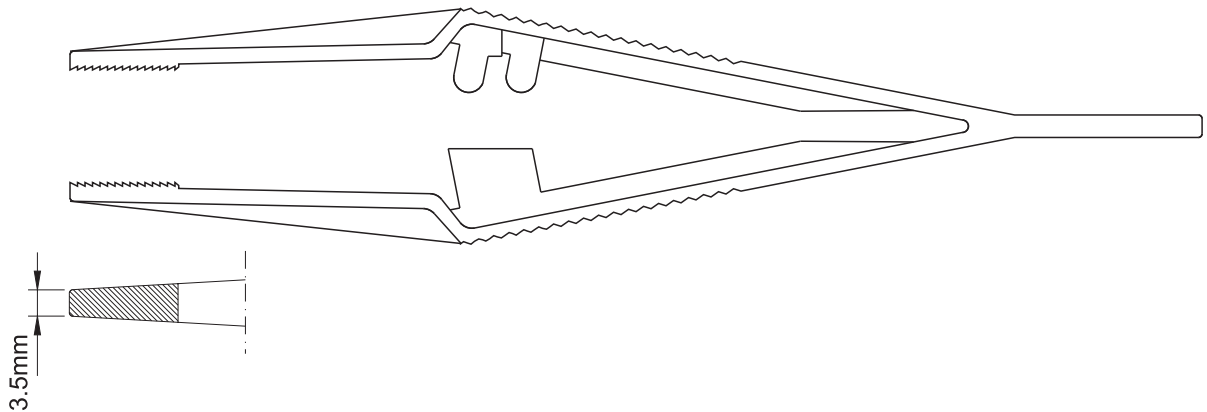

707-B	5102	1,08 €	Modell 707-B, Polyamid, glasfaserverstärkt, 85mm <i>Model 707-B, polyamide, glass-filled, 3 3/8inch</i>
766-B	5100	2,42 €	Modell 766-B, Polyamid, glasfaserverstärkt, 150mm <i>Model 766-B, polyamide, glass-filled, 5 7/8inch</i>
767-B	5250	1,46 €	Modell 767-B, Polyamid, glasfaserverstärkt, 125mm <i>Model 767-B, polyamide, glass-filled, 5inch</i>

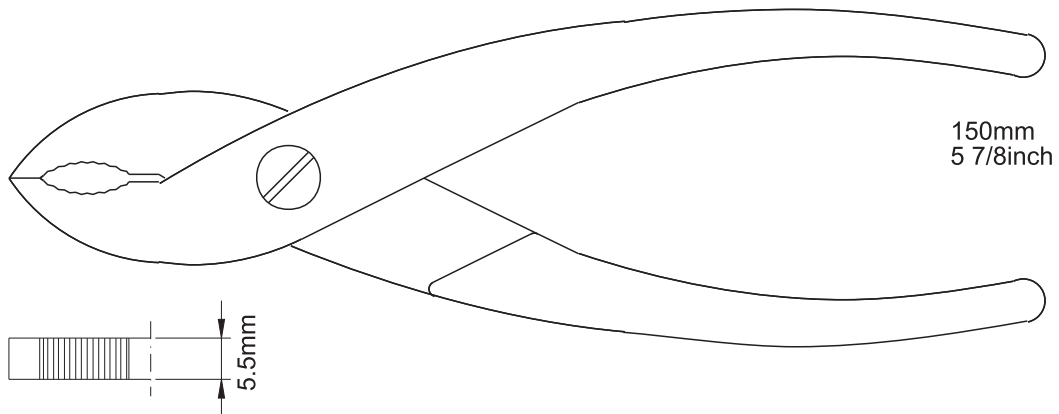

P1 2710 **12,20 €** P1, Kombizange aus Delrin, glasfaserverstärkt
P1, Combination plier made of glass-filled Delrin

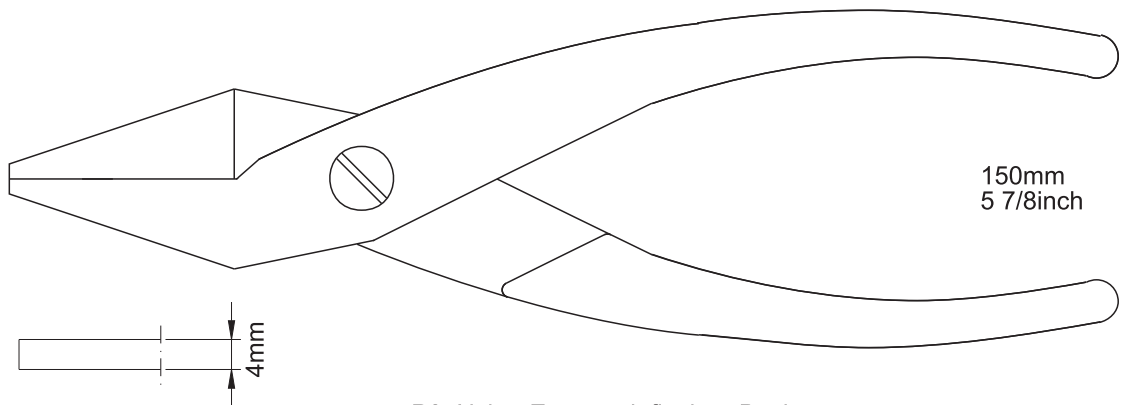

P2 2712 **12,50 €** P2, Nylon-Zange mit flachen Backen
P2, Nylon plier with flat, smooth nose

Nichtmetallische Handwerkzeuge

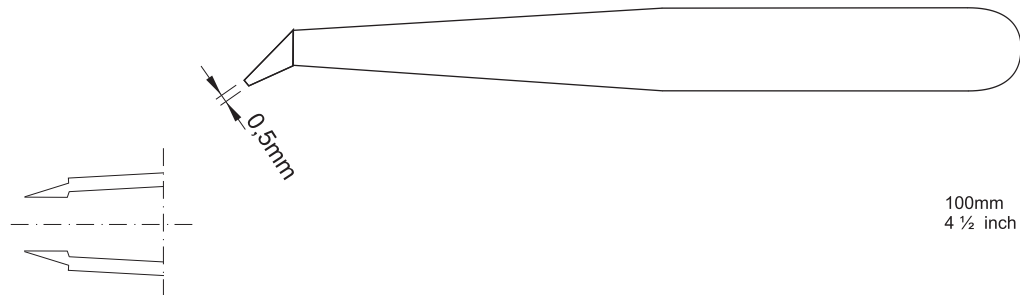

90

5333

6,56 €

Stabile, 0,5mm breite Spitze, 45° winklig gebogen,
Delrin, glasfaserverstärkt

*Strong, 0,5mm wide tips, 45° curved,
Delrin, glass-filled*

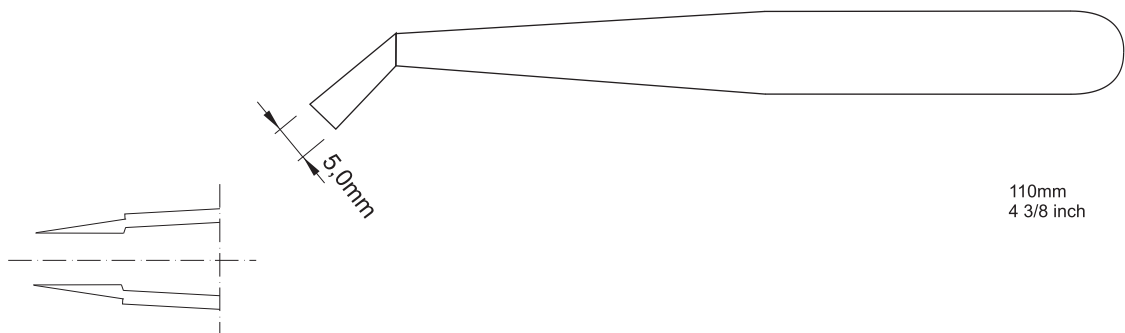

09

5331

6,56 €

Stabile, 5mm breite Spitze, 45° winklig gebogen,
Delrin, glasfaserverstärkt

*Strong, 5mm wide tips, 45° curved,
Delrin, glass-filled*

Nichtmetallische Handwerkzeuge



14-PTFE

5214

37,36 €

Aus massivem PTFE-Stab gefertigt
4mm breite Spitze
Hitzebeständig bis 280 °C
Made of solid PTFE in 1 piece
4mm wide tips
Heat-resistant up to 280 °C



24-PTFE

5224

36,08 €

Dito, jedoch 10mm breite Spitze
Hitzebeständig bis 280 °C
Same, but 10mm wide tips
Heat-resistant up to 280 °C

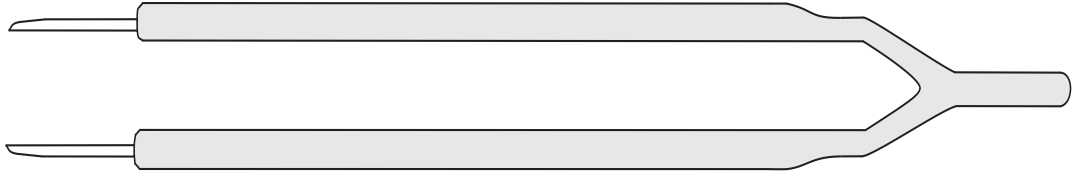
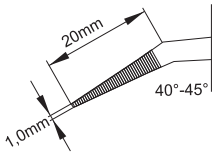

155 mm

22b isol.

9157

9,00€

Gebogen, mittelfeine Spitze, schutzisoliert

Bent, medium pointed, security-insulation

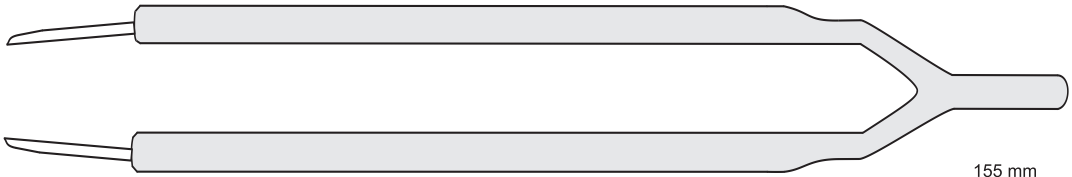
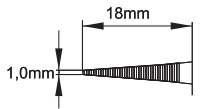

155 mm

22 isol.

9158

8,54 €

Gerade, mittelfeine Spitze, schutzisoliert

Straight, medium pointed, security-insulation

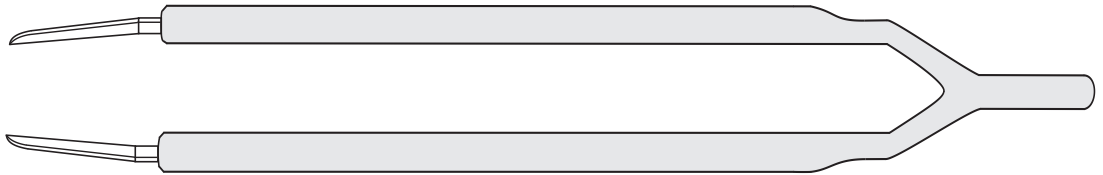
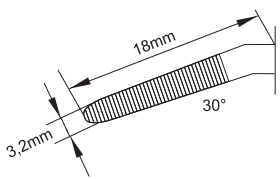

145 mm

40b isol.

3016

8,42 €

Stumpf, gebogen, mittelfeine Spitze, schutzisoliert

Blunt, curved, medium pointed, security-insulation

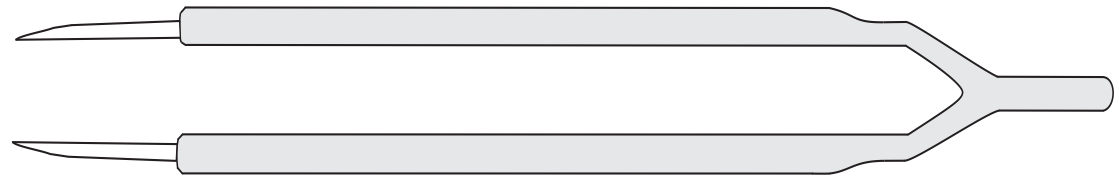
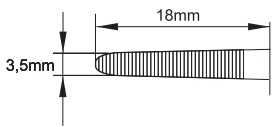

145 mm

40 isol.

3015

7,82 €

Stumpf, gerade, mittelfeine Spitze, schutzisoliert

Blunt, straight, medium pointed, security-insulation

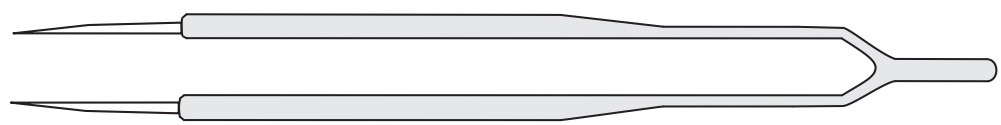
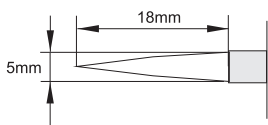

130 mm

AA isol.

8100

9,30 €

Spitz, universelles Modell, schutzisoliert

Pointed, multipurpose model, security-insulation



C5

115mm

C5

8305

35,00 €

Schneidepinzette für sehr feine Drähte, Form 5

Cutting Tweezer for very fine wires, Design 5

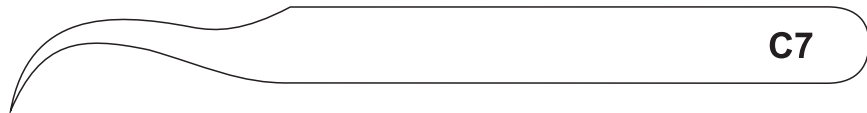

C7

120mm

C7

8307

38,30 €

Schneidepinzette für sehr feine Drähte, Form 7

Cutting Tweezer for very fine wires, Design 7

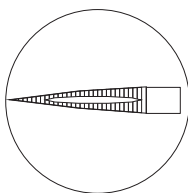

120mm



Feilchenfeldpinzette

Einteilig	7108	12,60 €	Feilchenfeldpinzette, hohle Grifffläche, mit Blutrinne in der Spitze
Einteilig	7109	15,70 €	Wie 7108, jedoch Rostfrei Same as 7108 but Stainless

Technicians helps

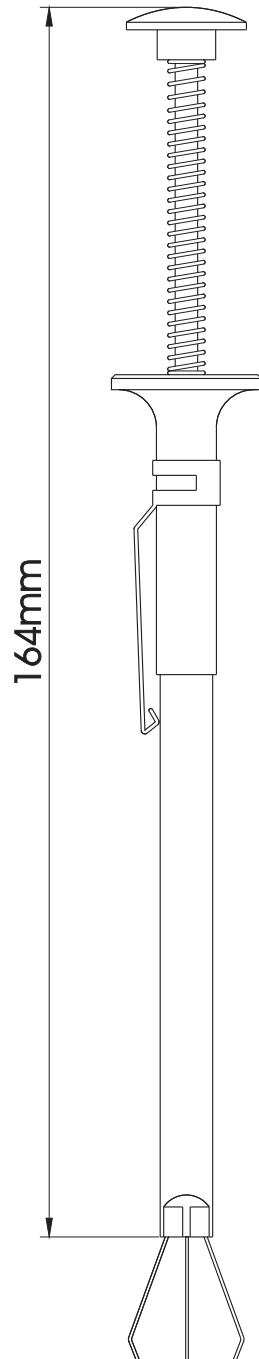

0761 **17,98 €**

Krallengreifer mit Clip, Taschenversion
Grösster \varnothing am Schaft 7,5mm
ideal zum Ablöten

*Gripper with Clip, pocket version,
max. Shank \varnothing 7,5mm
ideal for de-soldering*

Vakuum-Pinzetten

Vacuum-tweezers

Alle Vakuumpumpen mit Netzanschluss 220 Volt, andere Spannungen auf Anfrage lieferbar.
Auslieferung incl. Netzkabel, Stecker, Schalter sowie Schalldämpfer und Filter.
Gehäuse aus Aluminium, schwingungsgedämpft, mit Gummifüßen,
wahlweise mit zusätzlichem Blasanschluss.

*All vacuum pumps for 220V main power, other voltages available upon request.
Supplied with main cable, plug switch as well as silencer and filter.
Aluminium housing with rubber feet to absorb vibrations.
Additional blowing connection available as option.*

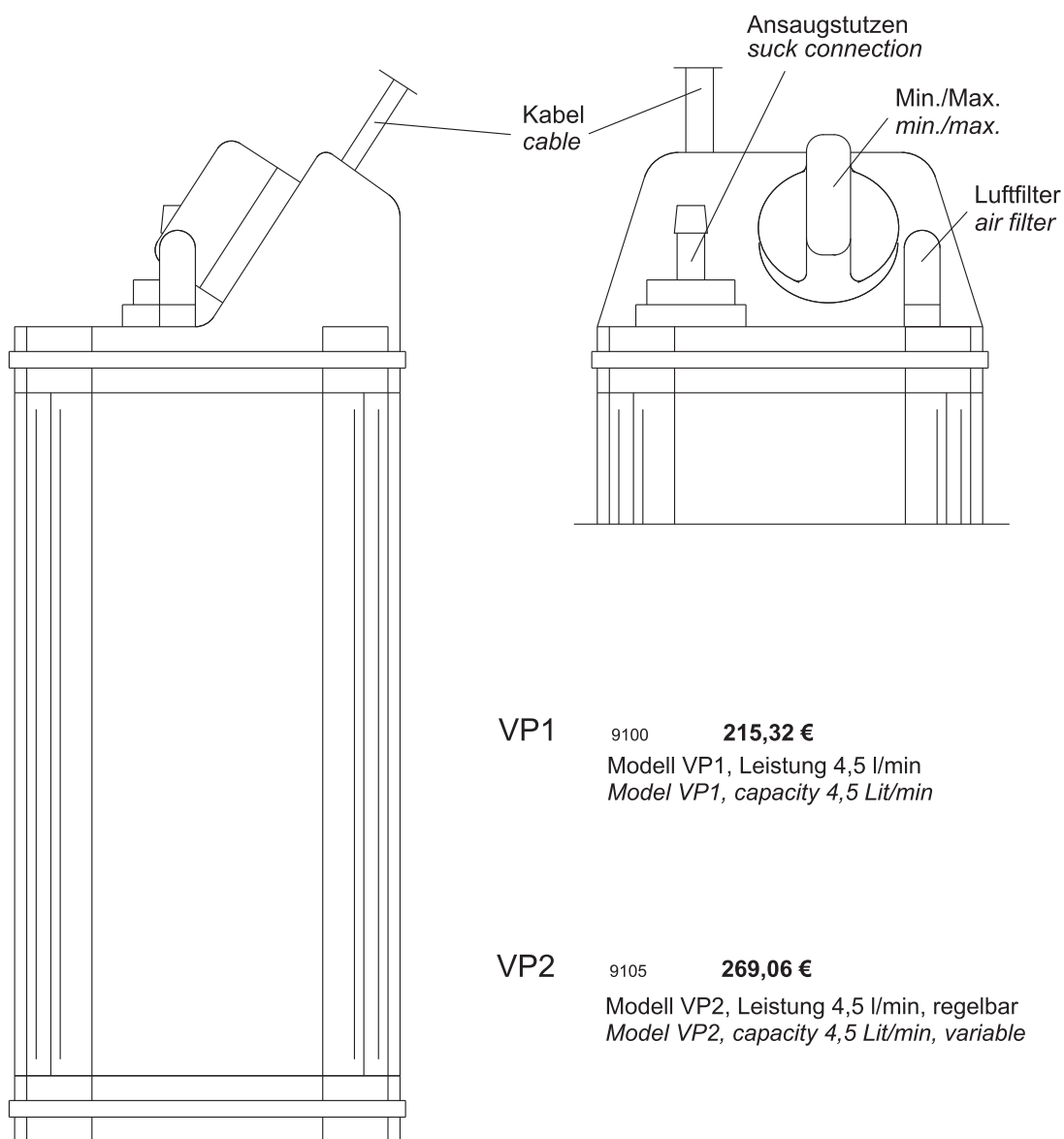

VP1 9100 **215,32 €**
Modell VP1, Leistung 4,5 l/min
Model VP1, capacity 4,5 Lit/min

VP2 9105 **269,06 €**
Modell VP2, Leistung 4,5 l/min, regelbar
Model VP2, capacity 4,5 Lit/min, variable

Vakuum-Pinzetten

Vacuum-tweezers

VP3

9110

502,32 €

Modell VP3, Leistung 6,5 l/min, regelbar
Model VP3, capacity 6,5 Lit/min, variable

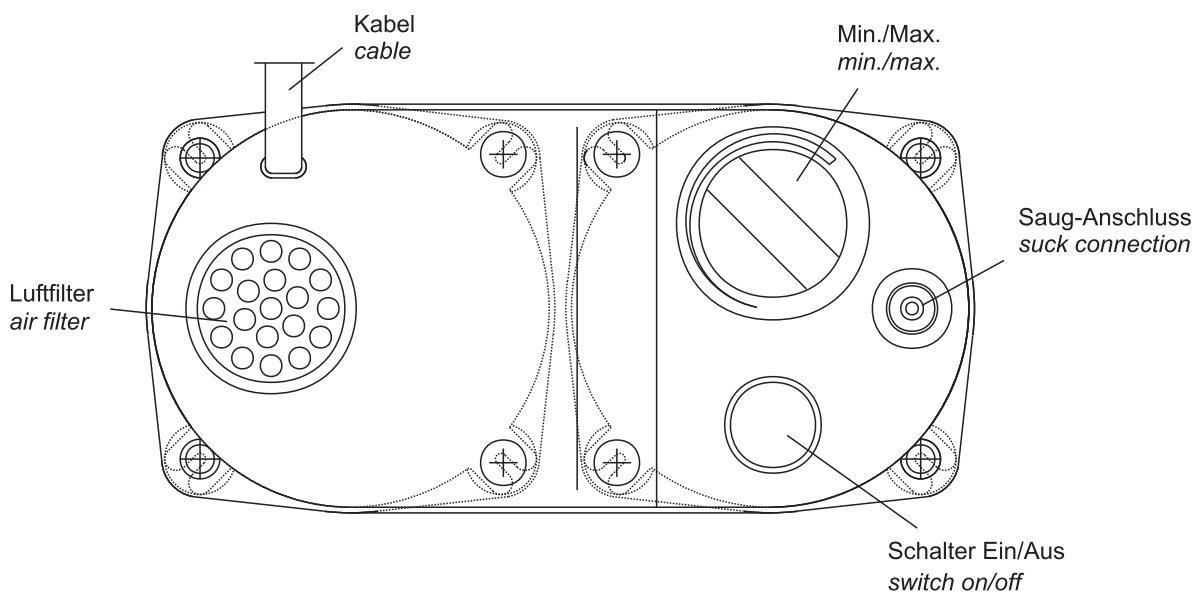
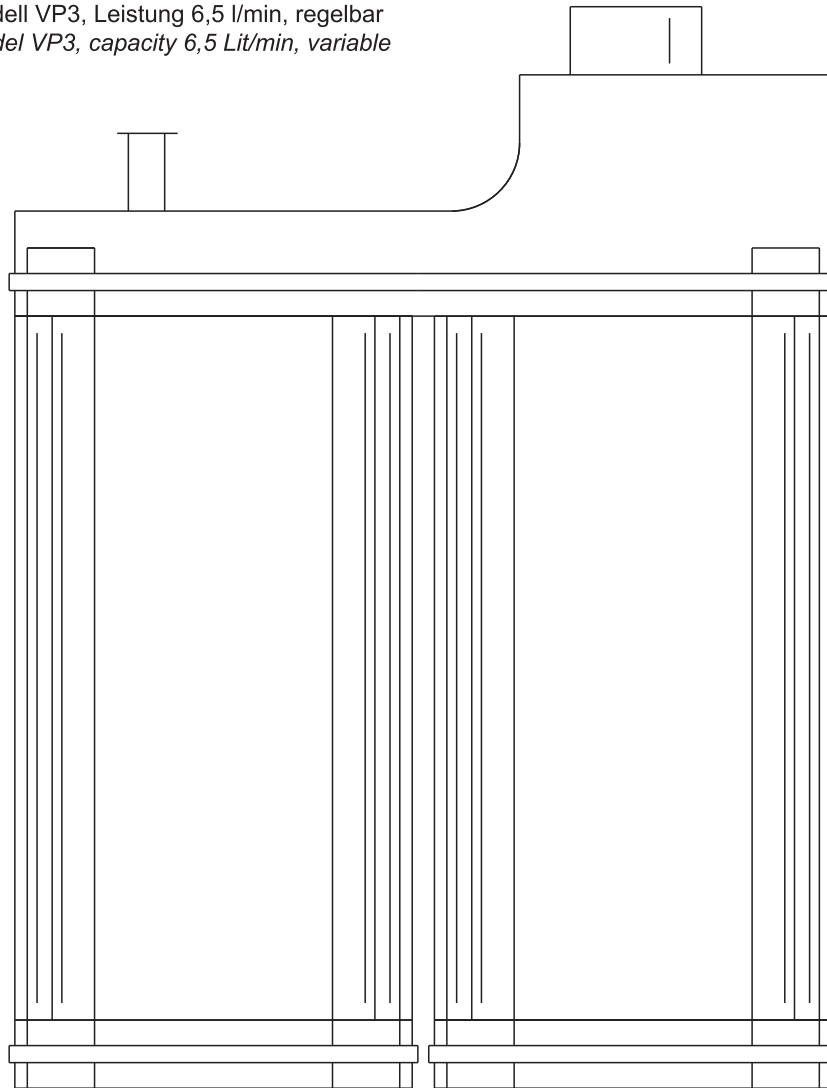

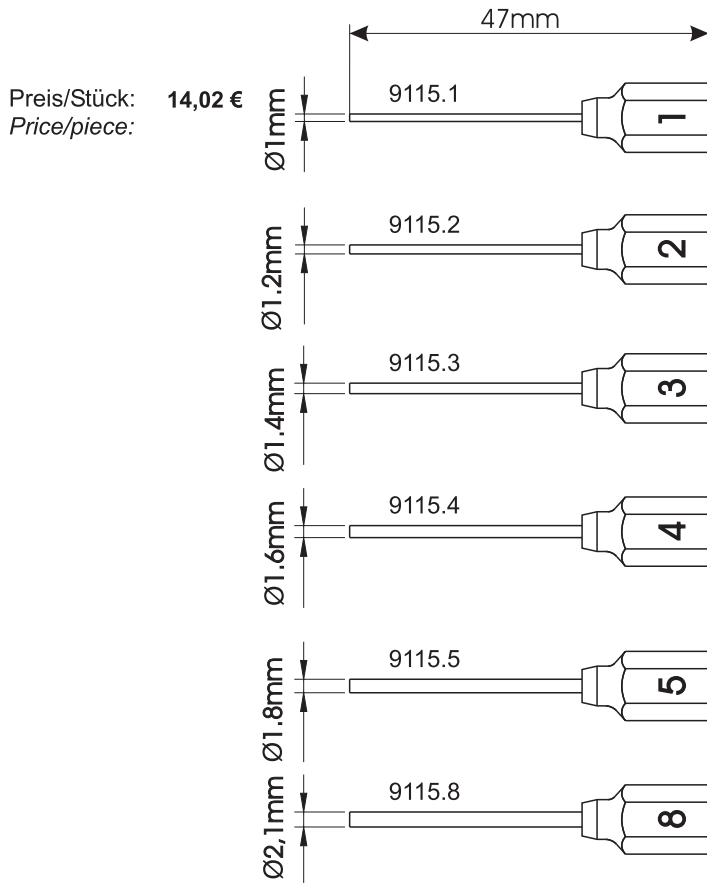

Preis/Stück: 14,02 €
Price/piece:

9116.1 Preis/Stück: 19,14 €
Price/piece:

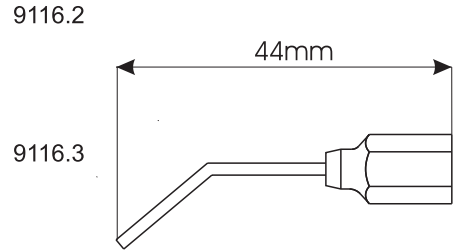

9115 Preis/Satz: 81,54 €
Price/set: Saugnadel-Sortiment, nichtrostend. Grössen: 1,0-1,2-1,4-1,6-1,8-2,1mm
Suction needle assortment, stainless. Sizes: 1,0-1,2-1,4-1,6-1,8-2,1mm

9116 Preis/Satz: 111,42 €
Price/set: Wie oben, jedoch 40° winklig gebogen
Same as 9115 but bent at 40°

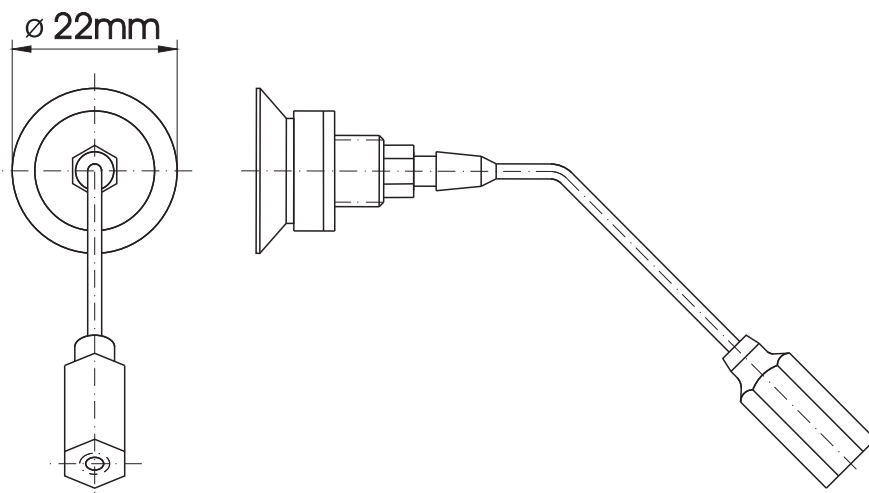

9121 90,60 €
Spezielsaugvorrichtung, speziell zum seitlichen Fassen grösserer Teile
hohe Saugkraft, 22mm
Special suction device, specifically for lateral grasping of large parts
high suction capacity, 22mm

VOMM-Vakuumpinzetten werden überall dort eingesetzt, wo die normalen Pinzetten nicht mehr schonend genug sind. Typische Anwendungsbereiche: Waferhandling, Montage kleiner optischer Systeme Handling von Solarzellen, Montage von Chips oder auch SMD-Bestückung.
Für besondere Anforderungen beschichten wir die mit den Artikeln in Berührung kommenden Teile auf Wunsch mit Teflon oder Halar (kontaminationsfrei).

*VOMM vacuum tweezers can be used wherever normal tweezers are not gentle enough.
Typical applications: wafer handling, assembly of small optical systems, handling of solar cells, chip assembly and fittings SMD's.
On request, we can coat the parts coming into contact with the articles, with Teflon or Halar (no contamination) for special applications.*

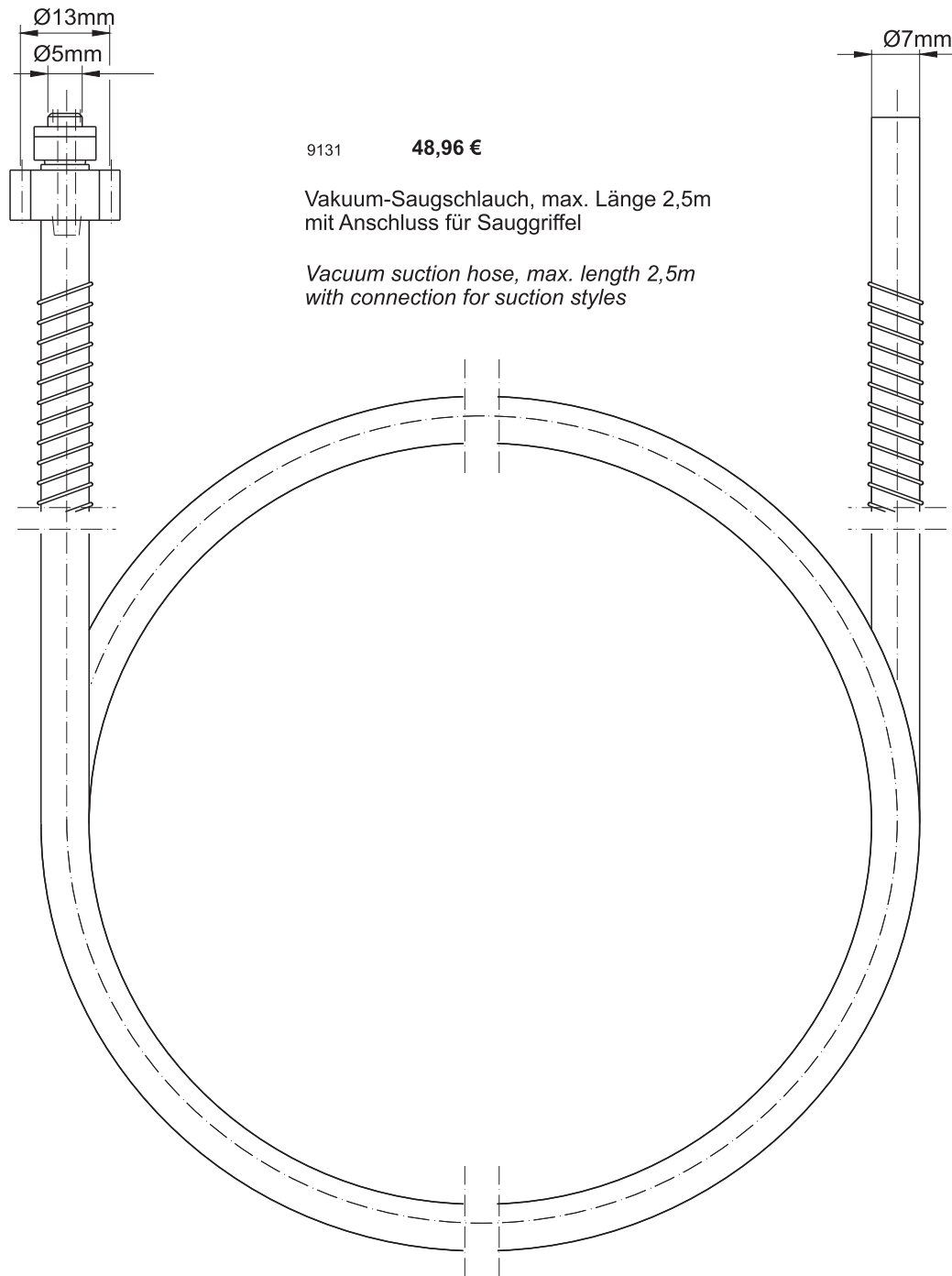

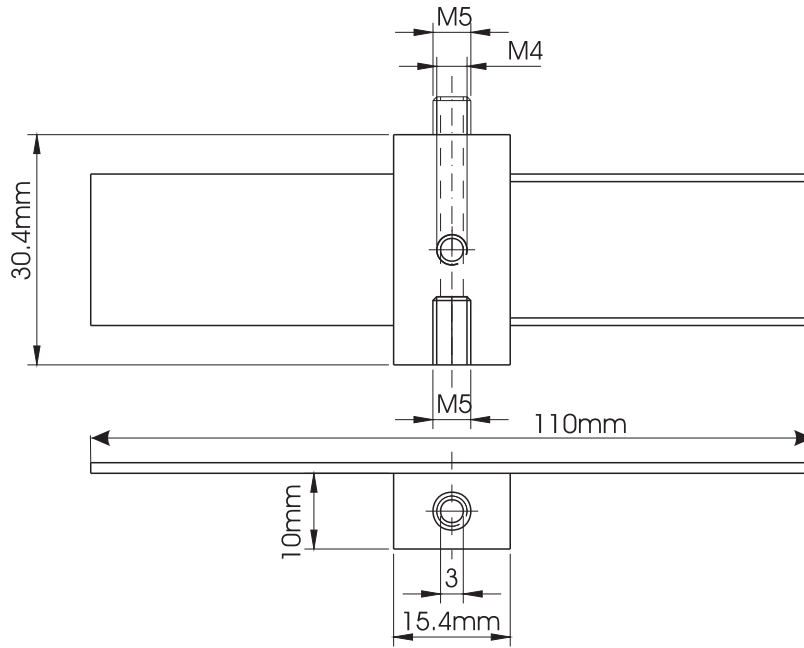

9130 **107,52 €** Finger-Sauggriffel, mit Klettband am Finger zu befestigen und durch den Daumen zu steuern, wiegt nur 15g
Finger-mounted suction styles, secured on finger by Velcro fastener, thumb-controlled, weighs only 15g

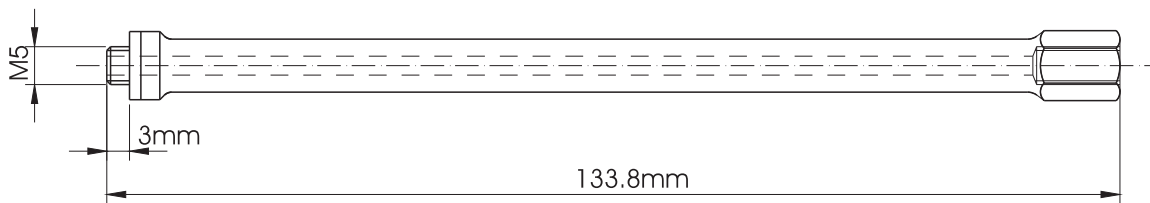

9125 **60,88 €** Hand-Sauggriffel mit Bypass-Öffnung zum Steuern des Vakuums, wiegt nur 20g
Hand-held suction styles with bypass aperture for controlling the vacuum, weighs only 20g

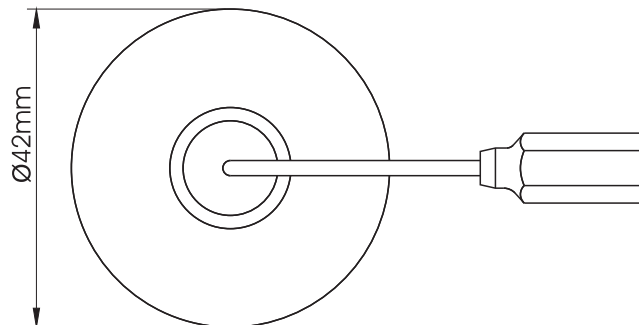

9120 **63,96 €** Spezialsaugvorrichtung, speziell zum seitlichen Fassen grösserer Teile, hohe Saugkraft, 42mm
Special suction device, specifically for lateral grasping of large parts, high suction capacity, 42mm

Tool-Servant

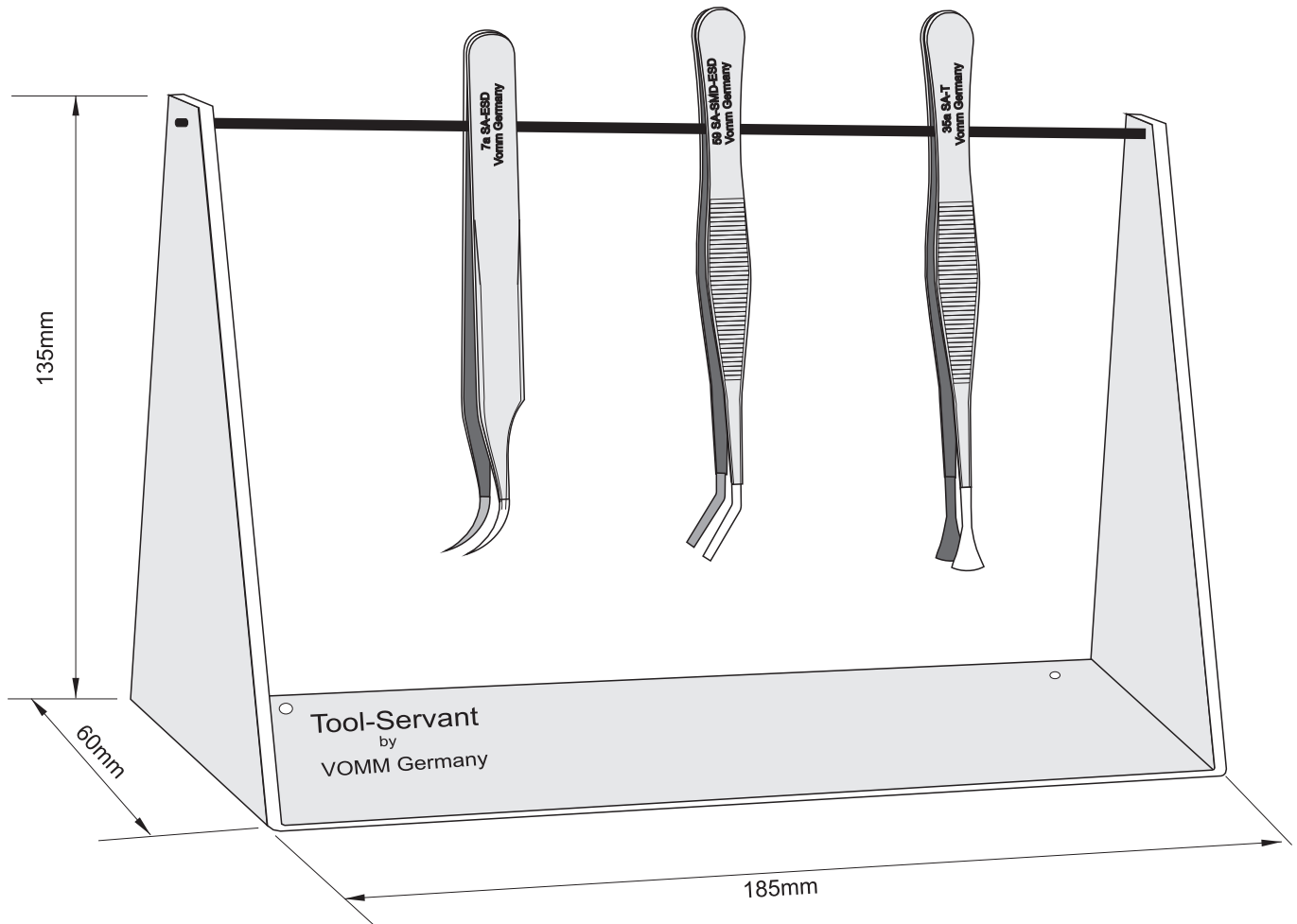

1150

21,66 €

Abmessungen: L 185mm x B 60mm x H 135mm
ESD-beschichtet, antistatisch-schwarz, säurebeständig

Measurement: L 185mm x W 60mm x H 135mm
ESD-coated, antistatic-black, anti-acid

Preis ohne Pinzetten!
Price without tweezers!





0451	9,24 €	Kunststoffgriff	Delrin	<i>Plastic handle</i>	<i>Delrin</i>	140 mm
------	---------------	-----------------	--------	-----------------------	---------------	--------



125 mm

0407	4,32 €	Griff, Messing, vernickelt / verchromt		<i>Brass, nickel-plated / chromated handle</i>		
0408	8,74 €	Griff, Rostfrei		<i>Stainless Steel handle</i>		

0467	34,40 €	Teleskopgriff, vernickelt verchromt		<i>Telescope-handle, nickel-plated / chromated</i>		
------	----------------	-------------------------------------	--	--	--	--



145 mm - 640 mm

Mundspiegel

zum Einbauen in obige Griffe

Mouth-mirrors to be implemented in above

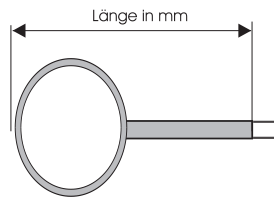

0510	8,88 €	∅	10 mm	35 mm
0514	8,88 €	∅	14 mm	35 mm
0516	3,88 €	∅	16 mm	35 mm
0518	4,00 €	∅	18 mm	38 mm
0520	4,16 €	∅	20 mm	38 mm
0522	4,24 €	∅	22 mm	39 mm
0524	4,50 €	∅	24 mm	39 mm
0526	5,04 €	∅	26 mm	43 mm
0528	5,32 €	∅	28 mm	43 mm
0530	5,66 €	∅	30 mm	44 mm
0560	18,98 €	∅	60 mm	71 mm

